

Contents

Features	1
Applications	1
Block diagram	1
Selection Guide	2
Pin Assignment	2
Absolute Maximum Ratings	2
Electrical Characteristics	3
Test Circuits	6
Operation	7
External Part Selection	10
Standard Circuits	12
Precautions	12
Dimensions	13
Markings	13
Taping	13
Characteristics (typical data).....	15
Reference Data (1).....	17
Reference Data (2).....	20

The S-8321/8322 Series is a CMOS PFM-control step-up switching regulator which mainly consists of a reference voltage source, an oscillation circuit, a power MOS FET, and a comparator. The new method PFM control circuit automatically switches the duty ratio according to load, offering products of low ripple over a wide range, high efficiency, high output current. A step-up switching regulator is constructed by externally connecting only a coil, a capacitor and a diode to the S-8321/8322 Series. This feature, along with its small package and low current consumption, makes the S-8321/8322 Series ideal for the power supply of portable equipment. A built-in protection circuit prevents damage to the IC by turning off the MOS FET when the voltage at CONT pin exceeds the limit during ON of the built-in MOS FET. For applications requiring a high output current, products used with an external transistor are also available in S-8322 Series.

■ Features

- Low voltage operation: 0.9 V min. ($I_{OUT} = 1 \text{ mA}$)
- Low input current:
 - During operation: $6.8 \mu\text{A}$ ($V_{OUT} = 3 \text{ V}$, no load, typ.)
 - During shutdown: $0.5 \mu\text{A}$ (max.)
- Duty ratio: auto-switching PFM control circuit type
- External parts: coil, diode, and capacitor only
- Output voltage: accuracy of $\pm 2.4\%$
- Shutdown function
- External transistor type is available (S-8322 Series)
- A Series : SOT-23-5 package
- B Series : SOT-23-3 package

■ Applications

- Power supplies for portable equipment such as pagers, handy calculators, and remote controllers
- Constant voltage power supplies for cameras, video equipment, and communications equipment
- Power supply for microcomputers

■ Block Diagram

(1) S-8321 Series

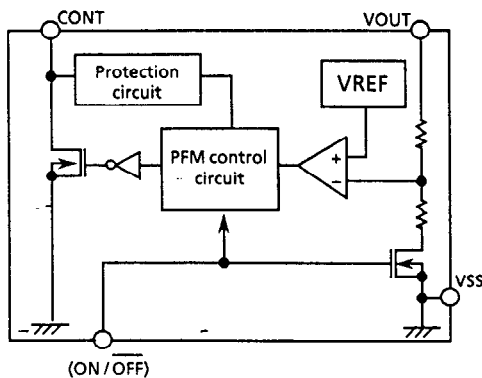

(2) S-8322 Series

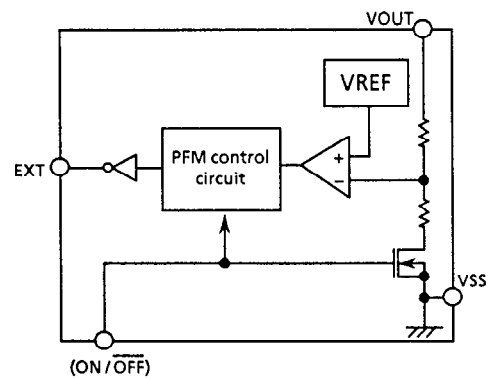

Figure 1

SMALL PACKAGE PFM CONTROL STEP-UP SWITCHING REGULATOR

S-8321/8322 Series

■ Selection Guide

1. Name of the Product

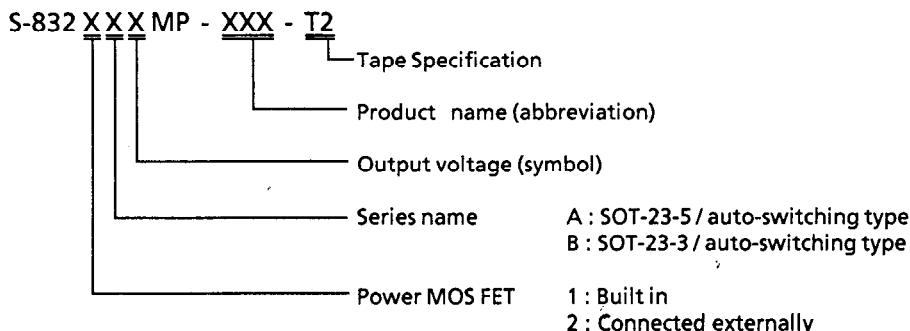

2. List of the Product

Output voltage (V) \ Products	S-8321A Series	S-8322A Series	S-8321B Series	S-8322B Series
2.5	S-8321AJMP-DNJ-T2	S-8322AJMP-DOJ-T2	—————	—————
2.7	S-8321ALMP-DNL-T2	—————	S-8321BLMP-DTL-T2	—————
3.0	S-8321AIMP-DNI-T2	S-8322AIMP-DOI-T2	S-8321BIMP-DTI-T2	S-8322BIMP-DUI-T2
3.3	S-8321AGMP-DNG-T2	S-8322AGMP-DOG-T2	S-8321BGMP-DTG-T2	—————
3.5	S-8321AFMP-DNF-T2	S-8322AFMP-DOF-T2	—————	—————
5.0	S-8321AAMP-DNA-T2	S-8322AAMP-DOA-T2	S-8321BAMP-DTA-T2	S-8322BAMP-DUA-T2

Consult our sales person for products with an output voltage other than specified above.

■ Pin Assignment

(1) SOT-23-5
Top view

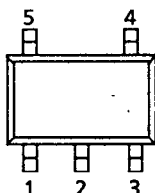

- 1 ON / OFF
- 2 V_{OUT}
- 3 NC
- 4 V_{SS}
- 5 CONT / EXT

(2) SOT-23-3
Top view

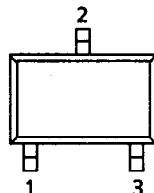

- 1 V_{SS}
- 2 V_{OUT}
- 3 CONT / EXT

Pin name	Functions
ON / OFF	Shutdown pin "H": normal operation (stepping up operation) "L": stop stepping up (circuit stop)
V _{OUT}	Output voltage pin and IC power supply
V _{SS}	GND
CONT	External inductor connection Note 1
EXT	External transistor connection Note 2

Note 1: S-8321 Series: Open drain output
Note 2: S-8322 Series: CMOS output

Figure 2

■ Absolute Maximum Ratings

(Unless otherwise specified: T_a = 25°C)

Parameter	Symbol	Ratings	Unit
V _{OUT} pin voltage	V _{OUT}	11	V
ON/OFF pin voltage	ON/OFF	V _{SS} - 0.3 to 11	V
CONT pin voltage	V _{CONT}	11	V
CONT pin current	I _{CONT}	300	mA
EXT pin voltage	V _{EXT}	V _{SS} - 0.3 to V _{OUT} + 0.3	V
EXT pin current	I _{EXT}	± 50	mA
Power dissipation	PD	150	mW
Operating temperature	T _{OPR}	- 40 to + 85	°C
Storage temperature	T _{STG}	- 40 to + 125	°C

SMALL PACKAGE PFM CONTROL STEP-UP SWITCHING REGULATOR

S-8321/8322 Series

Electrical Characteristics

1-1 S-8321AXMP

(Unless otherwise specified: Ta = 25°C)

Parameter	Symbol	Conditions	Min.	Typ.	Max.	Unit	Test circuit	
Output voltage	V _{OUT}		S-8321AAMP	4.880	5.000	5.120	V	1
			S-8321AFMP	3.416	3.500	3.584		
			S-8321AGMP	3.221	3.300	3.379		
			S-8321AIMP	2.928	3.000	3.072		
			S-8321ALMP	2.635	2.700	2.765		
S-8321AJMP	2.440	2.500	2.560					
Input voltage	V _{IN}		—	—	9			
Operation start voltage	V _{ST1}	I _{OUT} = 1mA	—	—	0.9			
Oscillation start voltage	V _{ST2}	No external parts, voltage applied to V _{OUT} , CONT pulled up to 5 V by 10kΩ	—	—	0.8		2	
Input voltage at no load	I _{IN}	No load	S-8321AAMP	—	9.0	15.0	—	—
			S-8321AFMP	—	7.2	12.0		
			S-8321AGMP	—	7.0	11.7		
			S-8321AIMP	—	6.8	11.4		
			S-8321ALMP	—	6.8	11.4		
S-8321AJMP	—	6.7	11.1					
Current consumption 1	I _{SS1}	V _{OUT} = output voltage × 0.95	S-8321AAMP	—	49	71.4	—	—
			S-8321AFMP	—	31	50.9		
			S-8321AGMP	—	29	48.1		
			S-8321AIMP	—	26	44.0		
			S-8321ALMP	—	24	40.0		
S-8321AJMP	—	22	37.2					
Current consumption 2	I _{SS2}	V _{OUT} = output voltage + 0.5	S-8321AAMP	—	2.6	4.4	—	2
			S-8321AFMP	—	2.4	4.0		
			S-8321AGMP	—	2.3	3.9		
			S-8321AIMP	—	2.3	3.8		
			S-8321ALMP	—	2.3	3.8		
S-8321AJMP	—	2.2	3.7					
Shutdown current	I _{SSS}	Shutdown pin = 0 V	—	—	0.5			
Switching current	I _{SW}	V _{CONT} = 0.4V	S-8321AAMP	99	148	—	—	—
			S-8321AFMP	82	122	—		
			S-8321AGMP	68	102	—		
			S-8321AIMP	68	102	—		
			S-8321ALMP	53	80	—		
S-8321AJMP	53	80	—					
Switching transistor leak current	I _{SWQ}	V _{OUT} = V _{CONT} = 0.9V	—	—	1.0	μA		
CONT limit voltage	V _{CONT LMT}		—	0.9	—	V		
Line regulation	ΔV _{OUT1}	V _{IN} = output voltage × 0.4 to × 0.6	—	30	60			
Load regulation	ΔV _{OUT2}	I _{OUT} = 10μA to I _{OUT} (below) × 1.25	—	30	60			
Output voltage temperature coefficient	ΔV _{OUT} /ΔTa	Ta = -40°C to +85°C	S-8321AAMP	—	±0.25	±1.25	—	1
			S-8321AFMP	—	±0.18	±0.90		
			S-8321AGMP	—	±0.17	±0.85		
			S-8321AIMP	—	±0.15	±0.75		
			S-8321ALMP	—	±0.14	±0.70		
S-8321AJMP	—	±0.13	±0.65					
Oscillation frequency	f _{osc}	V _{OUT} = output voltage × 0.95 Measure waveform at CONT pin	90	100	110	KHz	2	
Duty ratio 1	Duty1	V _{OUT} = output voltage × 0.95 Measure waveform at CONT pin	70	75	80	%	—	
Duty ratio 2	Duty2		—	50	—			
Shutdown pin input voltage	V _{SH}	V _{OUT} = output voltage × 0.95 Judge the oscillation at CONT pin	0.75	—	—	V	2	
	V _{SL1}	V _{OUT} = output voltage × 0.95 Judge the stop at CONT pin	When V _{OUT} ≥ 1.5V	—	—			0.3
	V _{SL2}		When V _{OUT} < 1.5V	—	—			0.2
Efficiency	EFFI		S-8321AAMP	—	85	—	—	1
			S-8321AFMP	—	80	—		
			S-8321AGMP	—	80	—		
			S-8321AIMP	—	80	—		
			S-8321ALMP	—	70	—		
S-8321AJMP	—	70	—					

External parts used:

- Coil CD54 (100μH) of Sumida Electric Co., Ltd.
- Diode MA729 (schottky type) of Matsushita Electronic Components Co., Ltd.
- Capacitor F93 (16 V, 22 μF, tantalum type) of Nichicon Corporation

V_{IN} = output voltage × 0.6 applied, I_{OUT} = output voltage / 250Ω

Note: Output voltage specified above is the typical value of the output voltage.

SMALL PACKAGE PFM CONTROL STEP-UP SWITCHING REGULATOR

S-8321/8322 Series

1-2 S-8321BXM P

(Unless otherwise specified: Ta = 25°C)

Parameter	Symbol	Conditions	Min.	Typ.	Max.	Unit	Test circuit	
Output voltage	V _{OUT}		S-8321BAMP	4.880	5.000	5.120	V	1
			S-8321BGMP	3.221	3.300	3.379		
			S-8321BIMP	2.928	3.000	3.072		
			S-8321BLMP	2.635	2.700	2.765		
Input voltage	V _{IN}		—	—	9	V	2	
Operation start voltage	V _{ST1}	I _{OUT} = 1mA	—	—	0.9			
Oscillation start voltage	V _{ST2}	No external parts, voltage applied to V _{OUT} , CONT pulled up to 5 V by 10kΩ	—	—	0.8	μA	2	
Input voltage at no load	I _{IN}	No load	S-8321BAMP	—	9.0			15.0
			S-8321BGMP	—	7.0			11.7
			S-8321BIMP	—	6.8			11.4
			S-8321BLMP	—	6.8			11.4
Current consumption 1	I _{SS1}	V _{OUT} = output voltage × 0.95	S-8321BAMP	—	49			71.4
			S-8321BGMP	—	29			48.1
			S-8321BIMP	—	26			44.0
			S-8321BLMP	—	24			40.0
Current consumption 2	I _{SS2}	V _{OUT} = output voltage + 0.5	S-8321BAMP	—	2.6			4.4
			S-8321BGMP	—	2.3	3.9		
			S-8321BIMP	—	2.3	3.8		
			S-8321BLMP	—	2.3	3.8		
Shutdown current	I _{SSS}	Shutdown pin = 0 V	—	—	0.5	mA	—	
Switching current	I _{SW}	V _{CONT} = 0.4V	S-8321BAMP	99	148			—
			S-8321BGMP	68	102			—
			S-8321BIMP	68	102			—
			S-8321BLMP	53	80	—		
Switching transistor leak current	I _{SWQ}	V _{OUT} = V _{CONT} = 0.9V	—	—	1.0	μA	V	
CONT limit voltage	V _{CONTLMT}		—	0.9	—			
Line regulation	ΔV _{OUT1}	V _{IN} = output voltage × 0.4 to × 0.6	—	30	60	mV	1	
Load regulation	ΔV _{OUT2}	I _{OUT} = 10μA to I _{OUT} (below) × 1.25	—	30	60			
Output voltage temperature coefficient	ΔV _{OUT} /ΔTa	Ta = -40°C to +85°C	S-8321BAMP	—	±0.25	±1.25	mV/°C	1
			S-8321BGMP	—	±0.17	±0.85		
			S-8321BIMP	—	±0.15	±0.75		
			S-8321BLMP	—	±0.14	±0.70		
Oscillation frequency	f _{osc}	V _{OUT} = output voltage × 0.95 Measure waveform at CONT pin	90	100	110	KHz	2	
Duty ratio 1	Duty1	V _{OUT} = output voltage × 0.95 Measure waveform at CONT pin	70	75	80	%		
Duty ratio 2	Duty2		—	50	—			
Efficiency	EFFI		S-8321BAMP	—	85	—	%	1
			S-8321BGMP	—	80	—		
			S-8321BIMP	—	80	—		
			S-8321BLMP	—	70	—		

External parts used:

- Coil CD54 (100μH) of Sumida Electric Co., Ltd.
- Diode MA729 (schottky type) of Matsushita Electronic Components Co., Ltd.
- Capacitor F93 (16 V, 22 μF, tantalum type) of Nichicon Corporation

V_{IN} = output voltage × 0.6 applied, I_{OUT} = output voltage / 250Ω

Note: Output voltage specified above is the typical value of the output voltage.

SMALL PACKAGE PFM CONTROL STEP-UP SWITCHING REGULATOR S-8321/8322 Series

2-1 S-8322AXMP

(Unless otherwise specified: Ta = 25°C)

Parameter	Symbol	Conditions	Min.	Typ.	Max.	Unit	Test circuit	
Output voltage	V _{OUT}		S-8322AAMP	4.880	5.000	5.120	V	3
			S-8322AFMP	3.416	3.500	3.584		
			S-8322AGMP	3.221	3.300	3.379		
			S-8322AIMP	2.928	3.000	3.072		
			S-8322AJMP	2.440	2.500	2.560		
Input voltage	V _{IN}		—	—	9			
Operation start voltage	V _{ST1}	I _{OUT} = 1mA	—	—	0.9			
Oscillation start voltage	V _{ST2}	No external parts, voltage applied to V _{OUT}	—	—	0.8		4	
Current consumption 1	I _{SS1}	V _{OUT} = output voltage × 0.95	S-8322AAMP	—	31	52.0	μA	4
			S-8322AFMP	—	20	33.0		
			S-8322AGMP	—	19	31.5		
			S-8322AIMP	—	17	28.9		
			S-8322AJMP	—	15	24.6		
Current consumption 2	I _{SS2}	V _{OUT} = output voltage + 0.5	S-8322AAMP	—	2.6	4.4	μA	4
			S-8322AFMP	—	2.4	4.0		
			S-8322AGMP	—	2.3	3.9		
			S-8322AIMP	—	2.3	3.8		
			S-8322AJMP	—	2.2	3.7		
Shutdown current	I _{SSS}	Shutdown pin = 0 V	—	—	0.5			
EXT pin output current	I _{EXTH}	E _{EXT} = V _{OUT} - 0.4V	S-8322AAMP	-5.3	-8.0	—	mA	—
			S-8322AFMP	-3.5	-5.3	—		
			S-8322AGMP	-3.5	-5.3	—		
			S-8322AIMP	-3.5	-5.3	—		
			S-8322AJMP	-2.7	-4.0	—		
	I _{EXTL}	E _{EXT} = 0.4V	S-8322AAMP	10.7	16.0	—		
			S-8322AFMP	7.0	10.5	—		
			S-8322AGMP	7.0	10.5	—		
			S-8322AIMP	7.0	10.5	—		
			S-8322AJMP	5.3	8.0	—		
Line regulation	ΔV _{OUT1}	V _{IN} = output voltage × 0.4 to × 0.6	—	30	60	mV	3	
Load regulation	ΔV _{OUT2}	I _{OUT} = 10μA to I _{OUT} (below) × 1.25	—	30	60	mV		
Output voltage temperature coefficient	ΔV _{OUT} /ΔTa	Ta = -40°C to +85°C	S-8322AAMP	—	±0.25	±1.25	mV/°C	3
			S-8322AFMP	—	±0.18	±0.90		
			S-8322AGMP	—	±0.17	±0.85		
			S-8322AIMP	—	±0.15	±0.75		
			S-8322AJMP	—	±0.13	±0.65		
Oscillation frequency	f _{osc}	V _{OUT} = output voltage × 0.95 Measure waveform at EXT pin	90	100	110	KHz	4	
Duty ratio 1	Duty1	V _{OUT} = output voltage × 0.95 Measure waveform at EXT pin	70	75	80	%	—	
Duty ratio 2	Duty2		—	50	—		—	
Shutdown pin input voltage	V _{SH}	V _{OUT} = output voltage × 0.95 Judge the oscillation at EXT pin	0.75	—	—	V	4	
	V _{SL1}	V _{OUT} = output voltage × 0.95 Judge the stop at EXT pin	When V _{OUT} ≥ 1.5V	—	—			0.3
	V _{SL2}		When V _{OUT} < 1.5V	—	—			0.2
Efficiency	EFFI		S-8322AAMP	—	85	—	%	3
			S-8322AFMP	—	80	—		
			S-8322AGMP	—	80	—		
			S-8322AIMP	—	80	—		
			S-8322AJMP	—	70	—		

External parts used:

- Coil CD54 (100μH) of Sumida Electric Co., Ltd.
- Diode MA720 (schottky type) of Matsushita Electronic Components Co., Ltd.
- Capacitor F93 (16 V, 47 μF, tantalum type) of Nichicon Corporation
- Transistor: 2SD1628G, SANYO
- Base resistance (R_b): 300Ω

V_{IN} = output voltage × 0.6 applied, I_{OUT} = output voltage / 100Ω

Note: Output voltage specified above is the typical value of the output voltage.

SMALL PACKAGE PFM CONTROL STEP-UP SWITCHING REGULATOR

S-8321/8322 Series

2-2 S-8322BXMP

(Unless otherwise specified: Ta = 25°C)

Parameter	Symbol	Conditions	Min.	Typ.	Max.	Unit	Test circuit	
Output voltage	V _{OUT}		S-8322BAMP	4.880	5.000	5.120	V	3
			S-8322BIMP	2.928	3.000	3.072		
Input voltage	V _{IN}		—	—	9			
Operation start voltage	V _{ST1}	I _{OUT} = 1mA	—	—	0.9			
Oscillation start voltage	V _{ST2}	No external parts, voltage applied to V _{OUT}	—	—	0.8			
Current consumption 1	I _{SS1}	V _{OUT} = output voltage × 0.95	S-8322BAMP	—	31	52.0	μA	4
			S-8322BIMP	—	17	28.9		
Current consumption 2	I _{SS2}	V _{OUT} = output voltage + 0.5	S-8322BAMP	—	2.6	4.4	μA	4
			S-8322BIMP	—	2.3	3.8		
Shutdown current	I _{SS3}	Shutdown pin = 0 V	—	—	0.5			
EXT pin output current	I _{EXTH}	E _{EXT} = V _{OUT} - 0.4V	S-8322BAMP	-5.3	-8.0	—	mA	—
			S-8322BIMP	-3.5	-5.3	—		
	I _{EXTL}	E _{EXT} = 0.4V	S-8322BAMP	10.7	16.0	—	mA	—
			S-8322BIMP	7.0	10.5	—		
Line regulation	ΔV _{OUT1}	V _{IN} = output voltage × 0.4 to × 0.6	—	30	60	mV	3	
Load regulation	ΔV _{OUT2}	I _{OUT} = 10μA to I _{OUT} (below) × 1.25	—	30	60	mV		
Output voltage temperature coefficient	ΔV _{OUT} /ΔTa	Ta = -40°C to +85°C	S-8322BAMP	—	±0.25	±1.25	mV/°C	3
			S-8322BIMP	—	±0.15	±0.75		
Oscillation frequency	f _{osc}	V _{OUT} = output voltage × 0.95 Measure waveform at EXT pin	90	100	110	KHz	4	
Duty ratio 1	Duty1	V _{OUT} = output voltage × 0.95 Measure waveform at EXT pin	70	75	80	%	—	
Duty ratio 2	Duty2		—	50	—	%	—	
Efficiency	EFF1		S-8322BAMP	—	85	—	%	3
			S-8322BIMP	—	80	—		

External parts used:

- Coil CD54 (100μH) of Sumida Electric Co., Ltd.
- Diode MA720 (schottky type) of Matsushita Electronic Components Co., Ltd.
- Capacitor F93 (16 V, 47 μF, tantalum type) of Nichicon Corporation
- Transistor: 2SD1628G, SANYO
- Base resistance (R_b): 300Ω

V_{IN} = output voltage × 0.6 applied, I_{OUT} = output voltage / 100Ω

Note: Output voltage specified above is the typical value of the output voltage.

Test Circuits

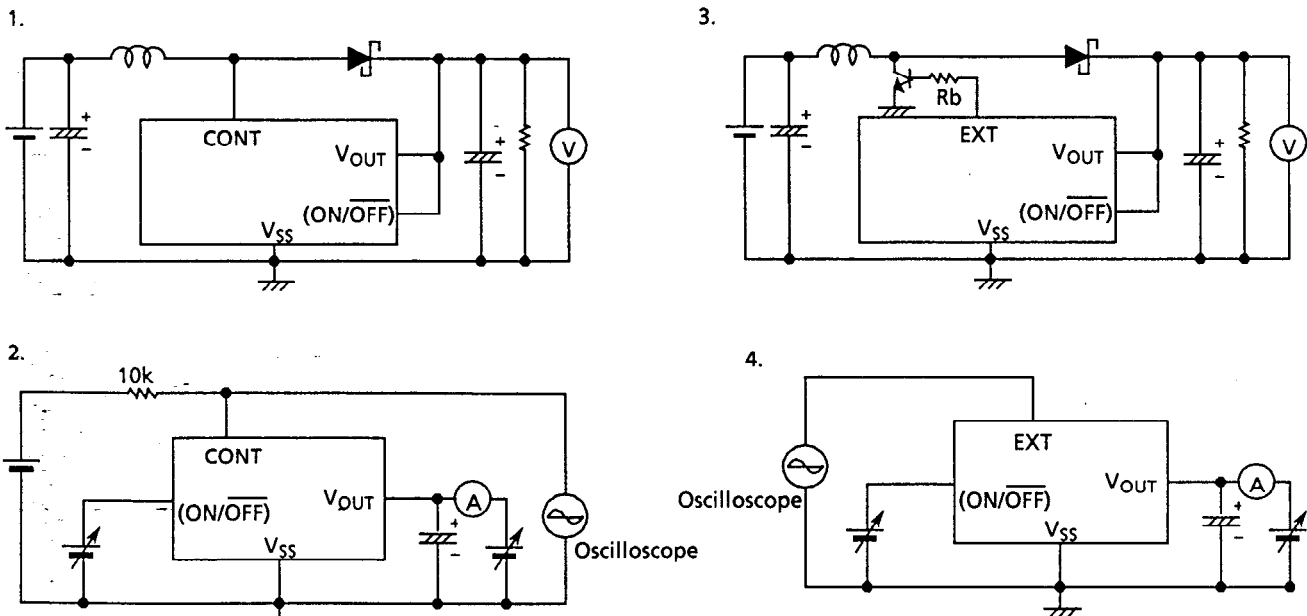

Figure 3

■ **Operation**

1. Step-Up DC/DC Converter

The S-8321/8322 Series is a DC/DC converter using a pulse frequency modulation method (PFM) with a low current consumption. Especially in the region of 100 μ A output load current, a high-efficiency DC/DC converter is obtained.

In conventional fixed-duty type PFM DC/DC converters, pulses are skipped at low output load current, causing fluctuation in ripple frequency of the output voltage, with the result of increase in ripple voltage. The S-8321/8322 Series ensures load drive capacity in the region of large output load current by making duty ratio 75%, whereas in the region of small output load current the S-8321/8322 Series lowers the load drive capacity by automatically switching the duty ratio to 50% (It may range from 50% to less than 75% depending upon coil and load conditions.) and thereby reduces pulse skip. This controls drop in ripple frequency and limits the increase in ripple voltage.

Figure 4 and Figure 5 show ripple voltage vs. output current characteristic. For example in the S-8321 AIMP, at $V_{IN} = 2.0$ V, a sudden change in ripple voltage around $I_{OUT} = 40$ mA is seen in Figure 4. This means that if the load switches from large current to small current, ripple voltage does not decrease in conventional fixed-duty type converter, whereas ripple voltage significantly decreases in duty ratio automatic switching type PFM type converter.

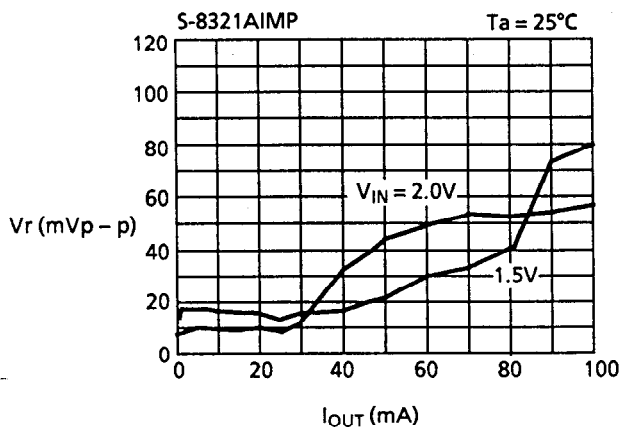

Figure4

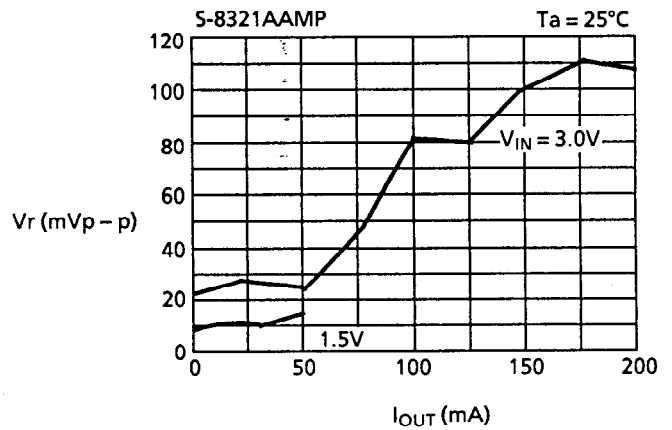

Figure5

Shutdown pin: Stops or starts step-up operation.

(A series only) Turning the shutdown pin low stops operation of all the internal circuits and reduces current consumption significantly. Do NOT use the shutdown pin in floating state because it has a structure shown in Figure 6 and is not pulled up or pulled down internally. Do NOT apply voltage of between 0.3 V and 0.75 V to the shutdown pin because applying such voltage increases the current consumption. If the shutdown pin is not used, connect it to VOUT pin.

The shutdown pin doesn't have hysteresis.

Shutdown pin	CR oscillation circuit	Output voltage
"H"	Operation	Fixed
"L"	Stop	$\approx V_{IN}^*$

* Voltage obtained by extracting the voltage drop due to DC resistance of the inductor and the diode forward voltage from V_{IN} .

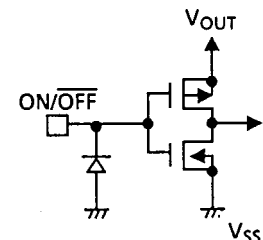

Figure 6

SMALL PACKAGE PFM CONTROL STEP-UP SWITCHING REGULATOR
S-8321/8322 Series

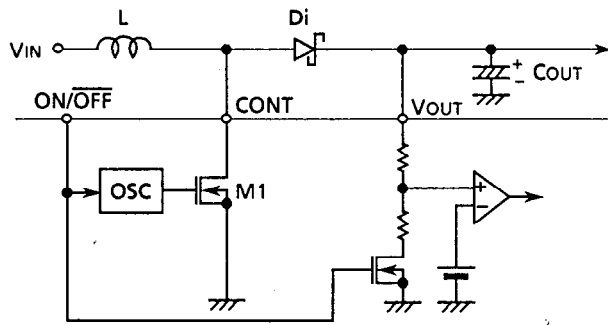

Figure 7

The following are basic equations [(1) through (7)] of the step-up switching regulator (see Figure 7).

Voltage at CONT pin the moment M1 is turned ON (current I_L flowing through L is zero):

$$V_A = V_S \dots\dots\dots (1)$$

(V_S : Non-saturated voltage of M1)

The change in I_L over time:

$$\frac{dI_L}{dt} = \frac{V_L}{L} = \frac{V_{IN} - V_S}{L} \dots\dots\dots (2)$$

Integration of the above equation (I_L):

$$I_L = \left(\frac{V_{IN} - V_S}{L} \right) \cdot t \dots\dots\dots (3)$$

I_L flows when M1 is turned ON (t_{ON}). The time of t_{ON} is determined by the oscillation frequency of the OSC.

The peak current (I_{PK}) after M1 is turned ON (t_{ON}):

$$I_{PK} = \left(\frac{V_{IN} - V_S}{L} \right) \cdot t_{ON} \dots\dots\dots (4)$$

The energy stored in L is represented with $\frac{1}{2}L (I_{PK})^2$.

When M1 is turned OFF (t_{OFF}), the energy stored in L is transmitted through a diode to the output capacitor. Then reverse voltage (V_L) is generated.

$$V_L = (V_{OUT} + V_D) - V_{IN} \dots\dots\dots (5)$$

(V_D : Diode forward voltage)

The voltage at CONT pin rises only by the voltage corresponding to $V_{OUT} + V_D$.

The change in the current flowing through the diode into V_{OUT} during t_{OFF} :

$$\frac{dI_L}{dt} = \frac{V_L}{L} = \frac{V_{OUT} + V_D - V_{IN}}{L} \dots\dots\dots (6)$$

Integration of the above equation is as follows:

$$I_L = I_{PK} - \left(\frac{V_{OUT} + V_D - V_{IN}}{L} \right) \cdot t \dots\dots\dots (7)$$

During t_{ON} , the energy is stored in L and is not transmitted to V_{OUT} . When receiving output current (I_{OUT}) from V_{OUT} , the energy of the capacitor (C_{OUT}) is consumed. As a result, the pin voltage of C_{OUT} is reduced, and goes to the lowest level after $M1$ is turned ON (t_{ON}). When $M1$ is turned OFF, the energy stored in L is transmitted through the diode to C_{OUT} , and the voltage of C_{OUT} rises drastically. V_{OUT} is a time function that indicates the maximum value (ripple voltage: V_{P-P}) when the current flowing through the diode into V_{OUT} and load current (I_{OUT}) match.

Next, the ripple voltage is found out as follows:

I_{OUT} vs t_1 (time) from when $M1$ is turned ON (t_{ON}) to when V_{OUT} reaches the maximum level:

$$I_{OUT} = I_{PK} - \left(\frac{V_{OUT} + V_D - V_{IN}}{L} \right) \cdot t_1 \dots\dots\dots (8)$$

$$\therefore t_1 = (I_{PK} - I_{OUT}) \left(\frac{L}{V_{OUT} + V_D - V_{IN}} \right) \dots\dots\dots (9)$$

When $M1$ is turned OFF (t_{OFF}), $I_L = 0$ (when the energy of the inductor is completely transmitted). Based on equation (7),

$$\left(\frac{L}{V_{OUT} + V_D - V_{IN}} \right) = \frac{t_{OFF}}{I_{PK}} \dots\dots\dots (10)$$

When substituting equation (10) for equation (9),

$$t_1 = t_{OFF} - \left(\frac{I_{OUT}}{I_{PK}} \right) \cdot t_{OFF} \dots\dots\dots (11)$$

Electric charge ΔQ_1 which is charged in C_{OUT} during t_1 :

$$\begin{aligned} \Delta Q_1 &= \int_0^{t_1} I_L dt = I_{PK} \cdot \int_0^{t_1} dt - \frac{V_{OUT} + V_D - V_{IN}}{L} \cdot \int_0^{t_1} t dt \\ &= I_{PK} \cdot t_1 - \frac{V_{OUT} + V_D - V_{IN}}{L} \cdot \frac{1}{2} t_1^2 \dots\dots\dots (12) \end{aligned}$$

When substituting equation (9) for equation (12):

$$\Delta Q_1 = I_{PK} - \frac{1}{2} (I_{PK} - I_{OUT}) \cdot t_1 = \frac{I_{PK} + I_{OUT}}{2} \cdot t_1 \dots\dots\dots (13)$$

A rise in voltage (V_{P-P}) due to ΔQ_1 :

$$V_{P-P} = \frac{\Delta Q_1}{C_{OUT}} = \frac{1}{C_{OUT}} \cdot \left(\frac{I_{PK} + I_{OUT}}{2} \right) \cdot t_1 \dots\dots\dots (14)$$

When taking into consideration I_{OUT} to be consumed during t_1 and ESR (Electric Series Resistance) of C_{OUT} , namely R_{ESR} :

$$V_{P-P} = \frac{\Delta Q_1}{C_{OUT}} = \frac{1}{C_{OUT}} \cdot \left(\frac{I_{PK} + I_{OUT}}{2} \right) \cdot t_1 + \left(\frac{I_{PK} + I_{OUT}}{2} \right) R_{ESR} - \frac{I_{OUT} \cdot t_1}{C_{OUT}} \dots\dots\dots (15)$$

When substituting equation (15) for equation (11):

$$V_{P-P} = \frac{(I_{PK} - I_{OUT})^2}{2I_{PK}} \cdot \frac{t_{OFF}}{C_{OUT}} + \left(\frac{I_{PK} + I_{OUT}}{2} \right) \cdot R_{ESR} \dots\dots (16)$$

Therefore to reduce the ripple voltage, it is important that the capacitor connected to the output pin has a large capacity and a small ESR.

■ External Part Selection

1. Inductor

To minimize a loss due to inductor DC resistance, select an inductor with a smallest possible DC resistance (less than 1 Ω). Set the inductance value around 22 μH to 1 mH.

To make the average value of the output voltage (V_{OUT}) constant, it is necessary to supply the energy corresponding to the output current (I_{OUT}) from the inductor. The amount of charge required for I_{OUT} is I_{OUT} × (t_{ON} + t_{OFF}). Because the inductor can supply the energy only during t_{OFF}, the charge is obtained by integrating equation (7) with 0 → t_{OFF}, namely,

$\frac{I_{PK}}{2} \cdot t_{OFF}$. Thus,

$$\frac{I_{PK}}{2} \cdot t_{OFF} = I_{OUT} \times (t_{ON} + t_{OFF}) \dots\dots\dots (17)$$

$$\therefore I_{PK} = 2 \cdot \frac{t_{ON} + t_{OFF}}{t_{OFF}} \cdot I_{OUT} \dots\dots\dots (18)$$

When the duty ratio of the OSC is 75%, I_{PK} = 8 · I_{OUT}. Therefore, an I_{PK} current which is eight times I_{OUT} flows into transistor M1.

The S-8321 Series includes a switching current control circuit which monitors the current flowing into the CONT pin by the voltage (CONT control voltage) and controls the current. This circuit prevents the IC destruction due to excess current.

If an inductor with a large value of L is selected, both I_{PK} and I_{OUT} decrease. Since the energy stored in the inductor is equal to ½L · (I_{PK})², the energy decreases because I_{PK} decreases in steps of squares offsetting the increase of L. As a result, stepping up at low voltage becomes difficult and the minimum operating input voltage becomes high. However, DC resistance loss in L and the M1 transistor becomes small because of decreased I_{PK}, and inductance efficiency improves.

On the other hand, if an inductor with a smaller value of L is selected, both I_{PK} and I_{OUT} increase. Accordingly the minimum operating input voltage becomes low but the inductance efficiency deteriorates.

[CAUTION] An excessively large I_{PK} may cause magnetic saturation for some core materials, leading to the destruction of the IC. Use a core of material satisfies I_{sat} > I_{PK} (I_{sat}: level of current that causes magnetic saturation).

2. Diode

Use an external diode that meets the following requirements:

- Low forward voltage (V_F < 0.3V)
- High switching speed (500 ns max.)
- Reverse voltage: V_{OUT} + V_F or more
- Rated current: I_{PK} or more

3. Capacitors (C_{IN}, C_{OUT})

A capacitor at the input side (C_{IN}) improves the efficiency by reducing the power impedance and stabilizing the input current. Select a C_{IN} value according to the impedance of the power supply used. The capacitor value should be around 10 μF.

A capacitor at the output side (C_{OUT}) is used for smoothing the ripple voltage. Therefore select a capacitor with a small ESR (Electric Series Resistance) and a large capacitance. The capacitor value should be 10 μF min. A tantalum electrolytic capacitor and an organic semiconductor capacitor are especially recommended because of their superior low-temperature characteristic and leakage current characteristic.

4. External transistor (S-8322 Series)

For the S-8322 Series, connecting an external transistor increases the output current. A bipolar transistor or an enhancement MOS FET transistor can be used as external transistor.

4.1. Bipolar transistor

A circuit example using a bipolar transistor (NPN), Sanyo 2SD1628G is shown in Figure 11. The R_b value determines the driving capacity to increase the output current using a bipolar transistor. A peripheral circuit example of the transistor is shown in Figure 8 to determine the R_b value.

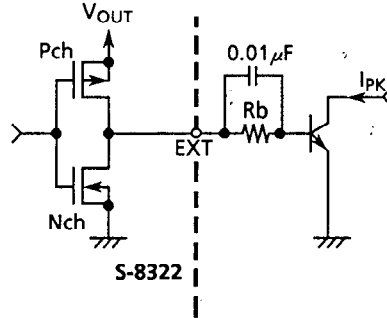

Figure 8 External transistor peripheral circuit

Stepping up capacity characteristics does not show much difference with the R_b value between 100 and 750 Ω , but 300 Ω is recommended. The current flows pulsating and there is voltage drop due to wiring resistance in an actual circuit, therefore optimum R_b value should be determined by experiment.

A speed-up capacitor connected in parallel with R_b resistance as shown in Figure 8 decreases the switching loss and improves the efficiency.

4.2. Enhancement MOS FET type

Figure 9 is a circuit example using NEC 2SK1959 MOS FET transistor (N-channel).

For a MOS FET, an N-channel power MOS FET should be used. In particular the EXT pin of the S-8322 can drive a MOS FET with a gate capacity of around 1000 pF. Because the gate voltage and current of the external power MOS FET are supplied from the stepped out output voltage V_{OUT} , the MOS FET is driven more effectively.

Since the ON resistor of the MOS FET might affect the output amperage as well as the efficiency, the threshold voltage should be low. When the output voltage is as low as 2.5 V the same as in the S-8322AJMP, the circuit operates only when the MOS FET has the threshold voltage lower than 2.5 V.

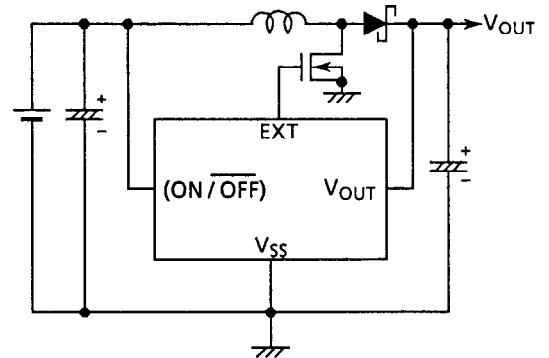

Figure 9 Circuit example using 2SK1959

SMALL PACKAGE PFM CONTROL STEP-UP SWITCHING REGULATOR

S-8321/8322 Series

Standard Circuits

(1) 8321 Series

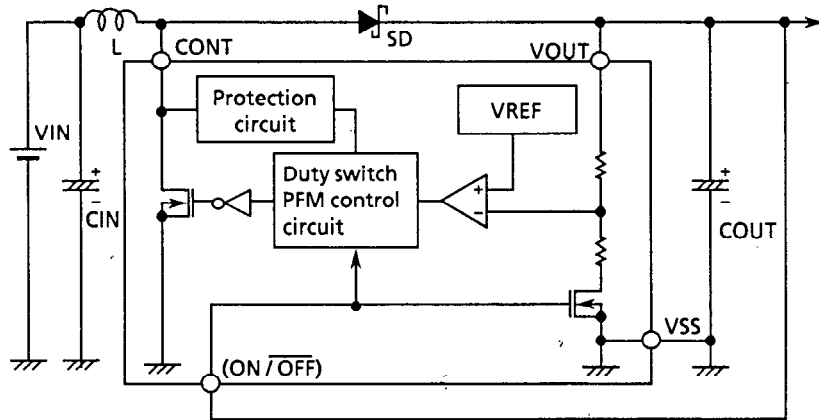

Figure 10

(2) 8322 Series

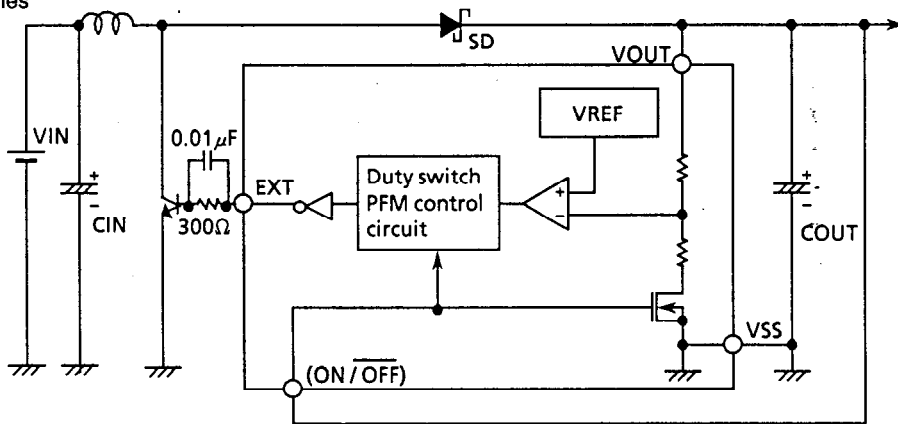

Figure 11

Precautions

- Mount external capacitors, a diode, and a coil as near as possible to the IC.
- Ripple voltage and spike noise occur in switching regulators. Because they largely depend on the coil and the capacitor used, check them using an actually mounted model.
- Seiko Instruments shall not be responsible for any patent infringement by products including S-8321/8322 Series in connection with the method of using S-8321/8322 Series in such products, the specification of such products, or the country of destination thereof.
- Make sure dissipation of the switching transistor (especially at a high temperatures) does not exceed the allowable power dissipation of the package.

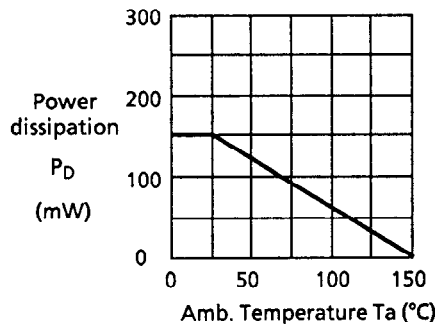
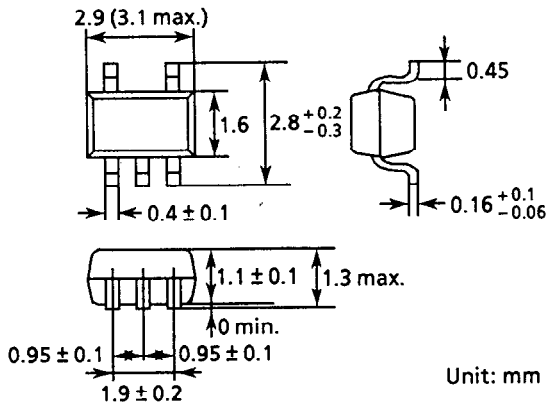

Figure 12 Power dissipation of the package (before mounting)

- When the impedance of the power supply is high, the shutdown pin is turned from "L" to "H" or VIN is connected to the power supply, note that the power supply voltage drops temporarily because the rush current flows into the power supply.

■ **Dimensions**

(1) SOT-23-5



(2) SOT-23-3

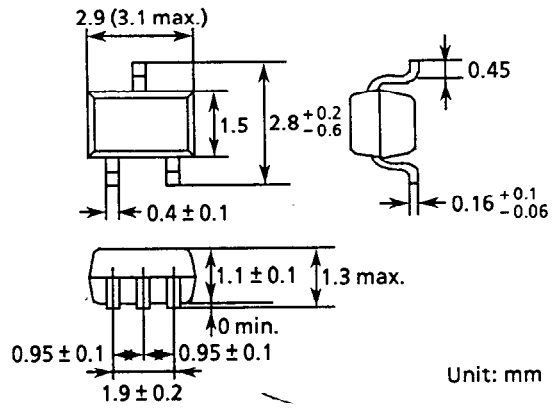
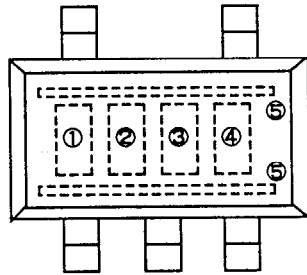

Figure 13

■ **Markings**

(1) S-8321/22AXMP



① to ③ Product name (abbreviation)
 ④ to ⑤ Lot No.

(2) S-8321/22BXMP

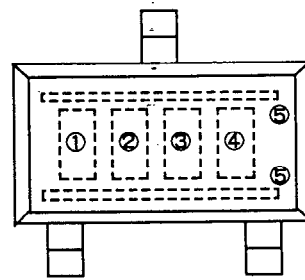

① to ③ Product name (abbreviation)
 ④ to ⑤ Lot No.

Figure 14

■ **Taping**

1. Tape specification

1-1 SOT-23-5

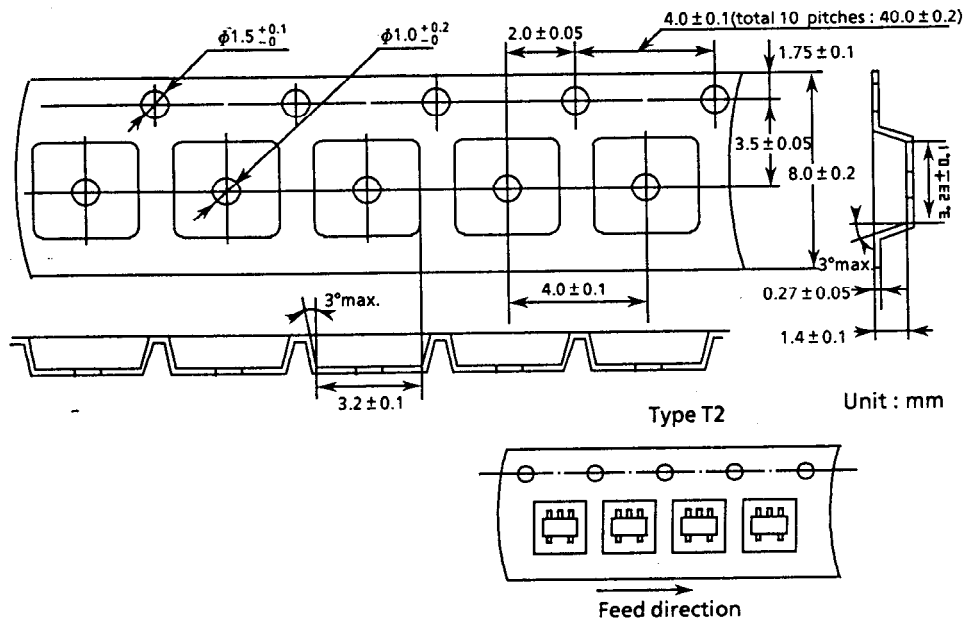

Figure 15

SMALL PACKAGE PFM CONTROL STEP-UP SWITCHING REGULATOR
S-8321/8322 Series

1-2 SOT-23-3

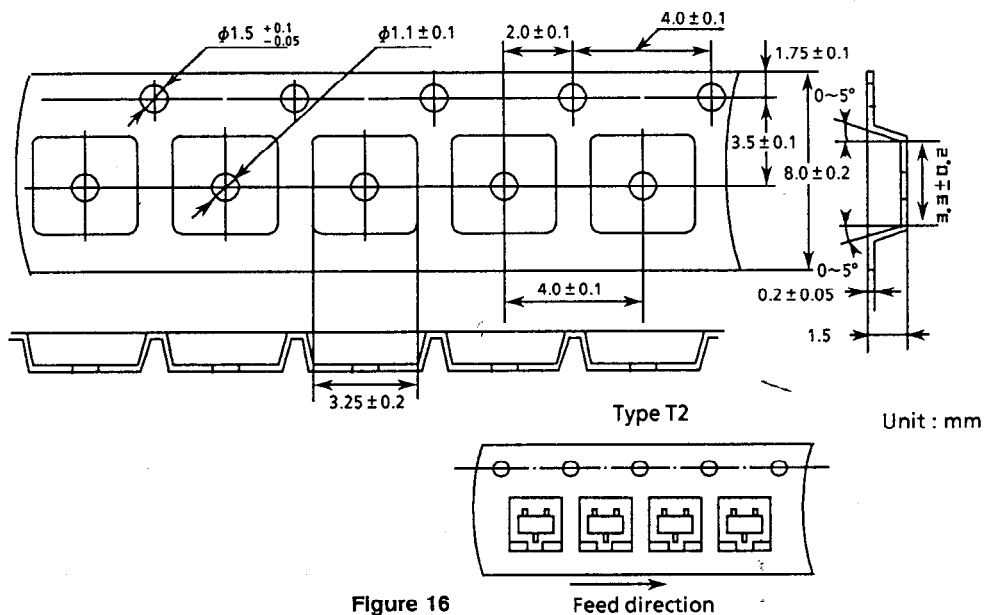

Figure 16

2. Reel specifications

One reel holds 3000 regulators.

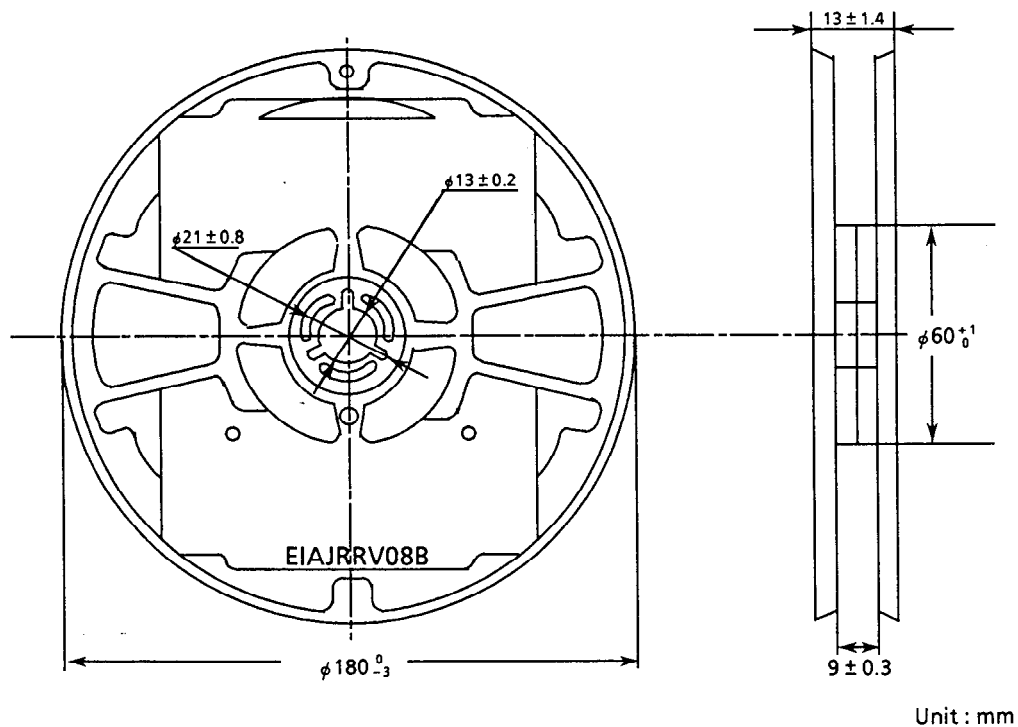
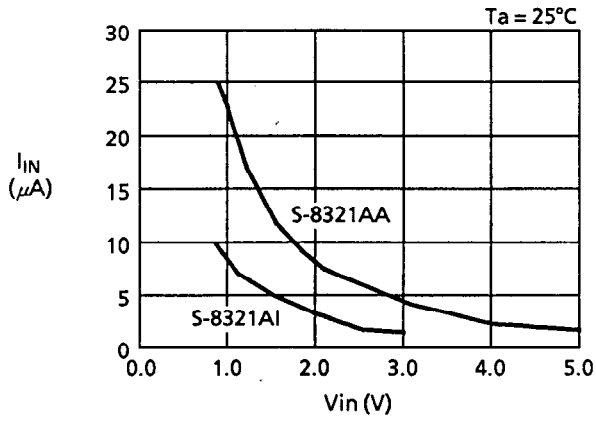

Figure 17

■ **Characteristics (typical data)**

1. Current consumption – Power voltage

- Power input current at no load (I_{IN})



I_{SS1} vs. V_{OUT} , T_a
S-8321A

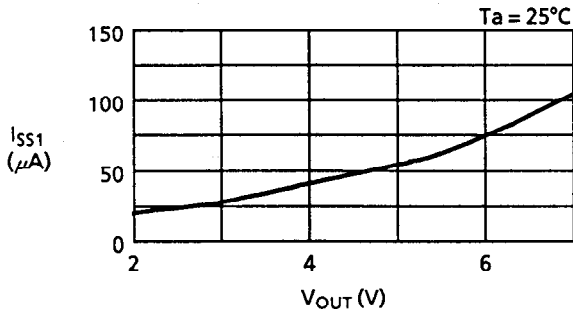

S-8321A

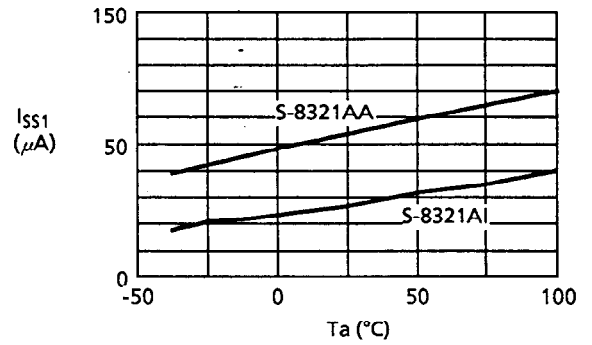

S-8322A

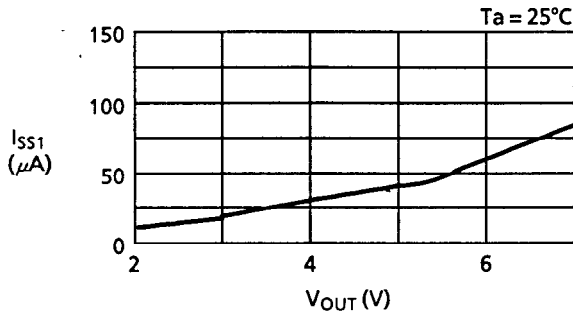

S-8322A

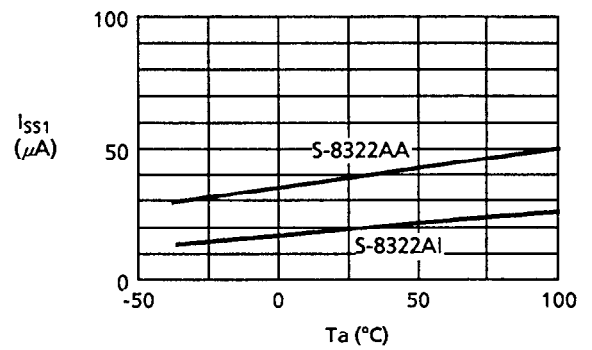

I_{SS2} vs. V_{OUT} , T_a

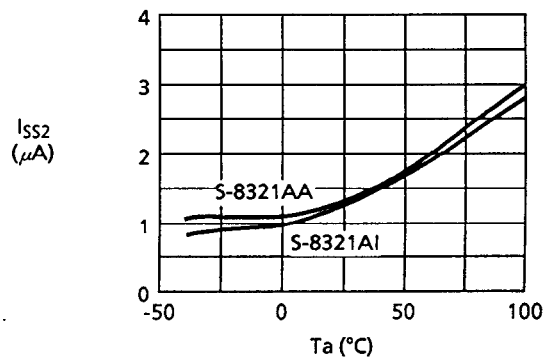
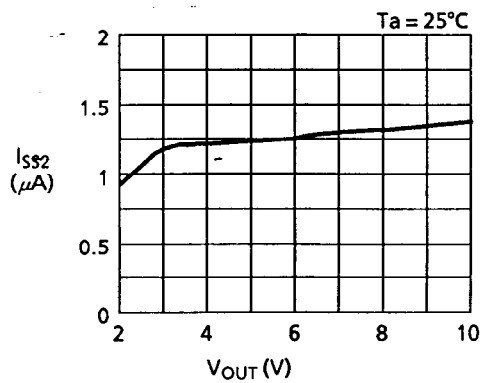

SMALL PACKAGE PFM CONTROL STEP-UP SWITCHING REGULATOR

S-8321/8322 Series

2. Oscillation frequency, duty ratio - Temperature

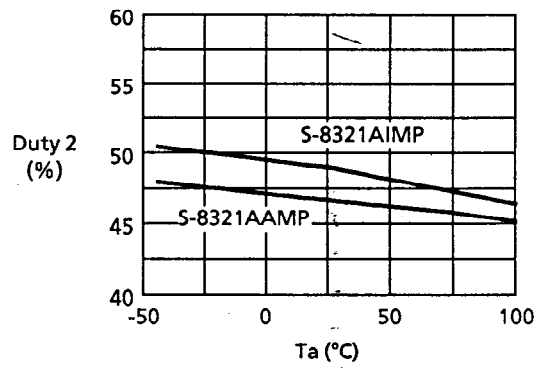
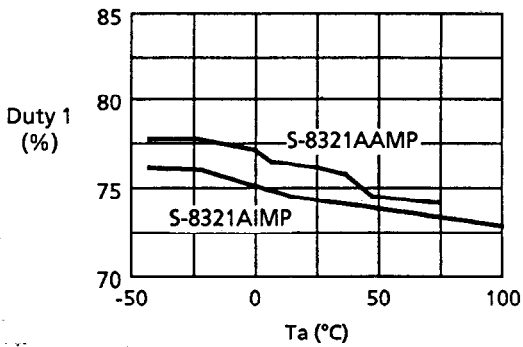
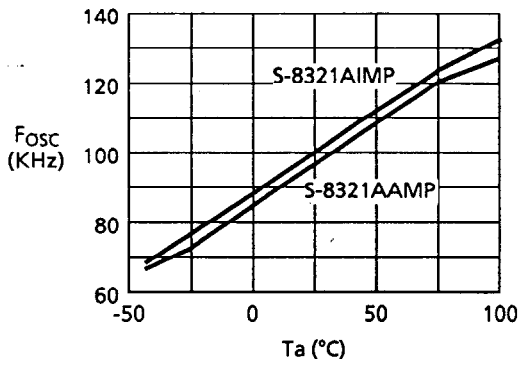

3. Switching current - Output voltage

I_{sw} vs. V_{OUT}

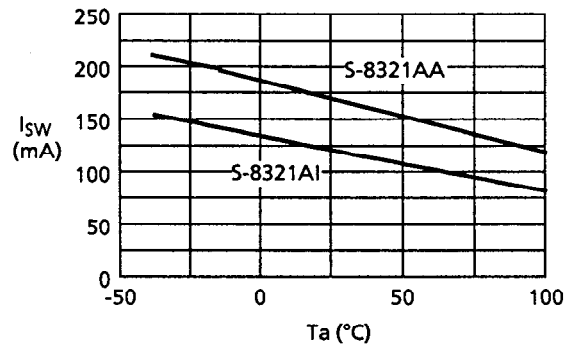
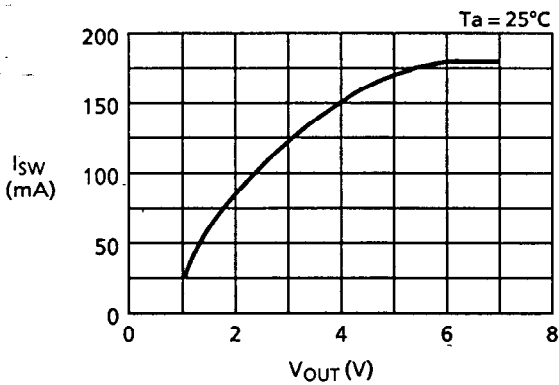

4. EXT pin output current - Output voltage

I_{EXTH} vs. V_{OUT} , T_a

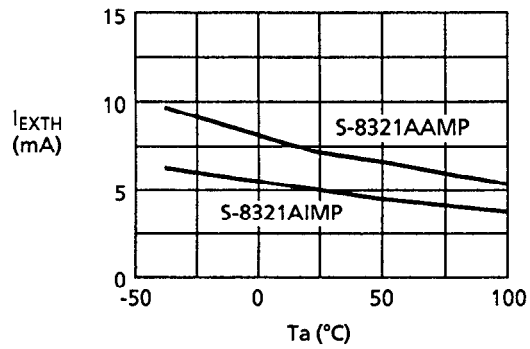
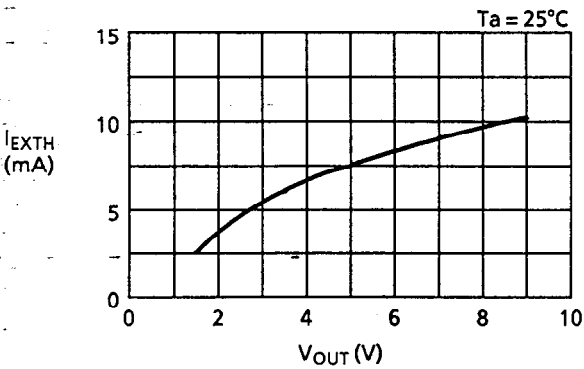

SMALL PACKAGE PFM CONTROL STEP-UP SWITCHING REGULATOR S-8321/8322 Series

I_{EXTL} vs. V_{OUT} , T_a

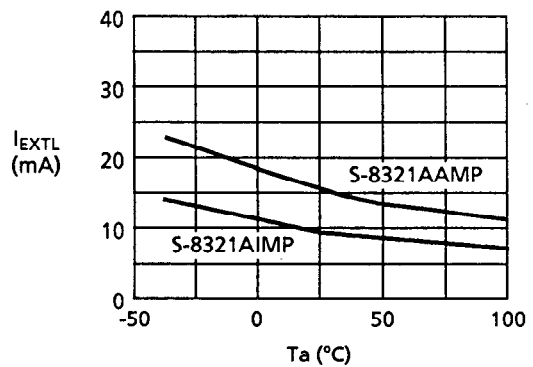
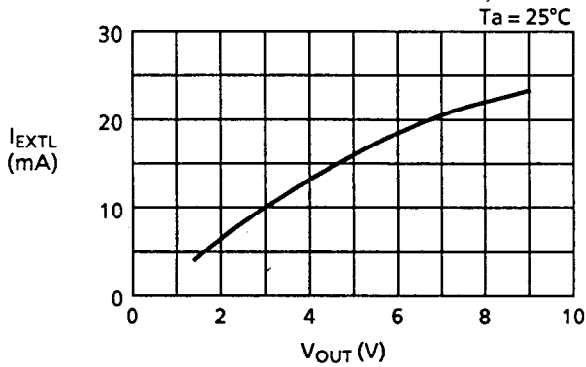

5. Operation start voltage, retention voltage - Temperature

V_{ST1} vs. T_a

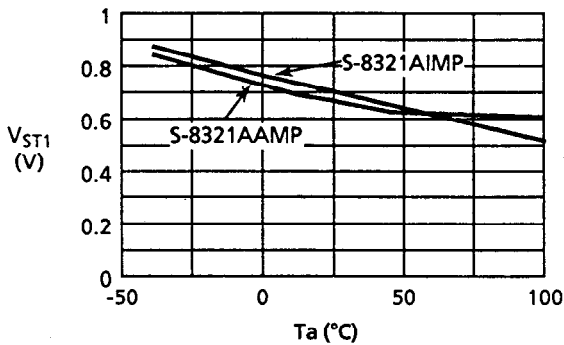

V_{HLD} vs. T_a

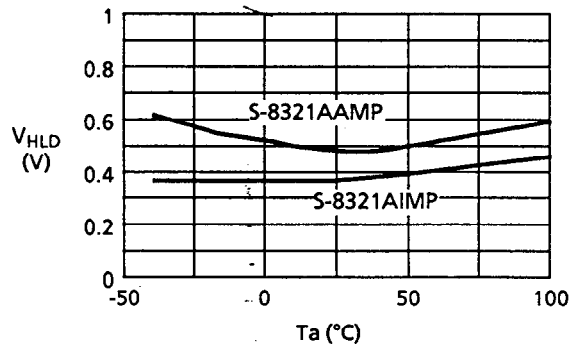

Reference Data (1)

1. Transit response characteristics

The conditions for the external parts are the same as specified in electrical characteristics.

1.1 Powering on ($T_a = 25^\circ\text{C}$)

S-8321AI $V_{IN} = 0 \rightarrow 1.8\text{V}$, $R_L = 250\Omega$

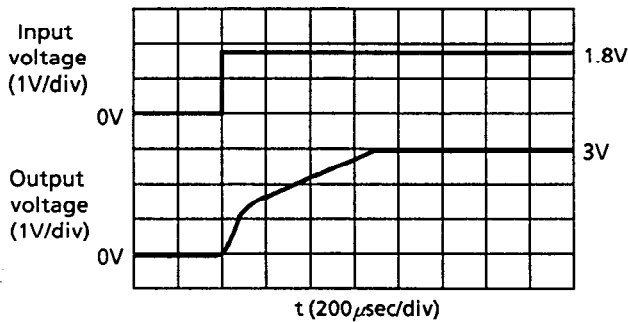

S-8321AA $V_{IN} = 0 \rightarrow 3\text{V}$, $R_L = 250\Omega$

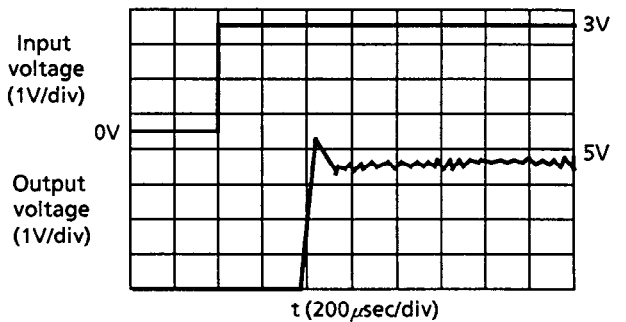

S-8322AI $V_{IN} = 0 \rightarrow 1.8\text{V}$, $R_L = 250\Omega$

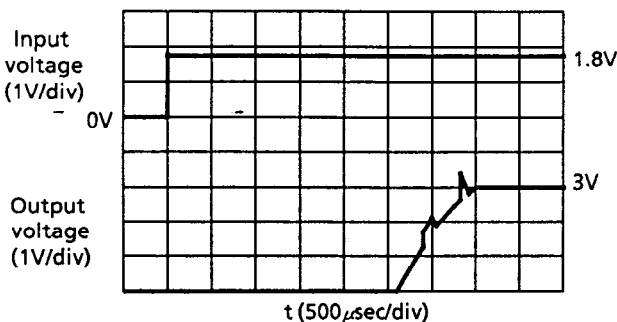

S-8322AA $V_{IN} = 0 \rightarrow 3\text{V}$, $R_L = 250\Omega$

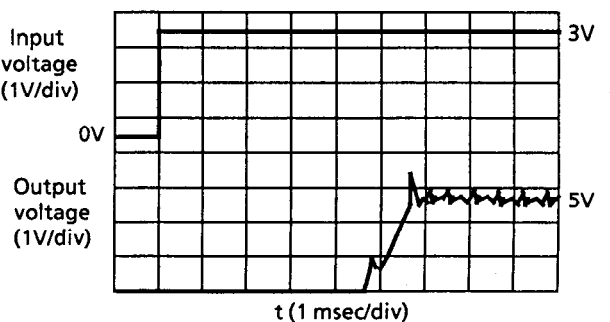

SMALL PACKAGE PFM CONTROL STEP-UP SWITCHING REGULATOR

S-8321/8322 Series

1.2 Power supply voltage change ($T_a = 25^\circ\text{C}$)

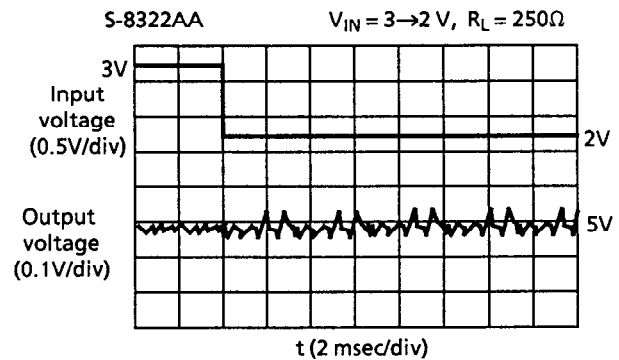
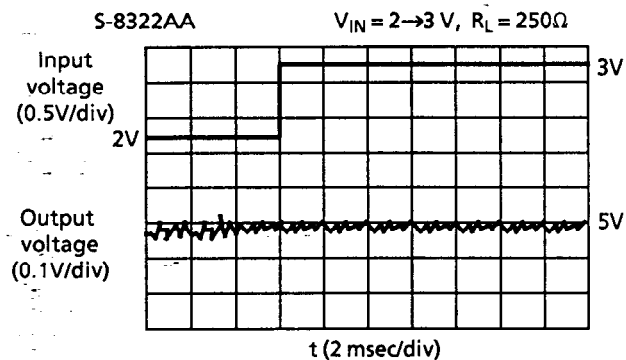
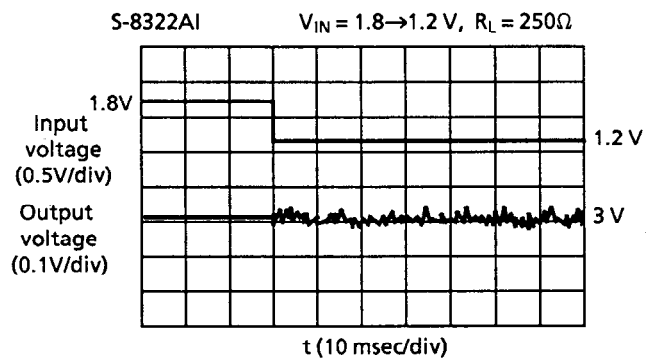
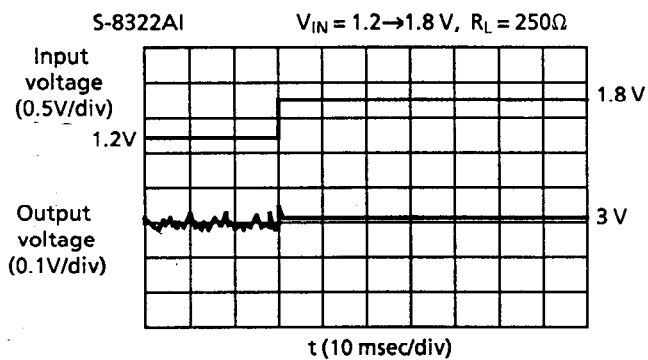
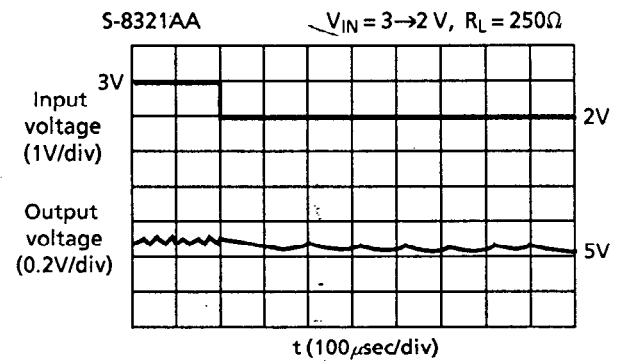
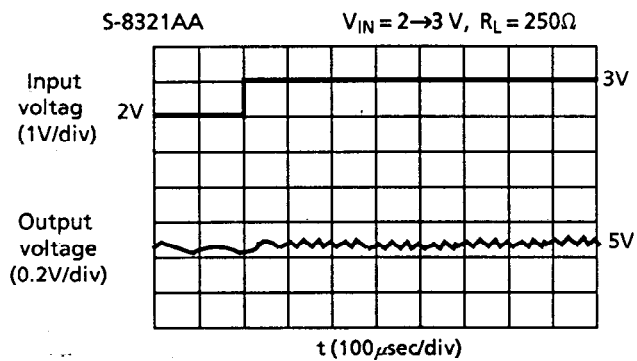
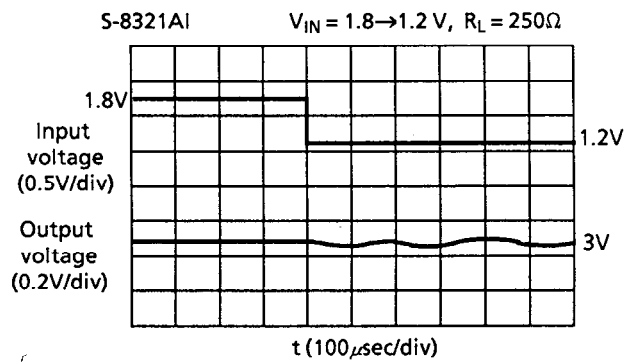
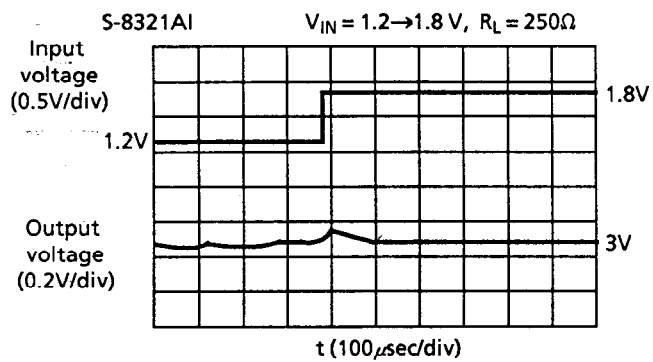

SMALL PACKAGE PFM CONTROL STEP-UP SWITCHING REGULATOR

S-8321/8322 Series

1.3 Load current change ($T_a = 25^\circ\text{C}$)

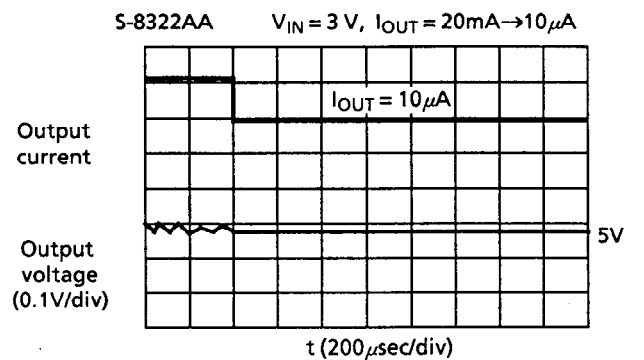
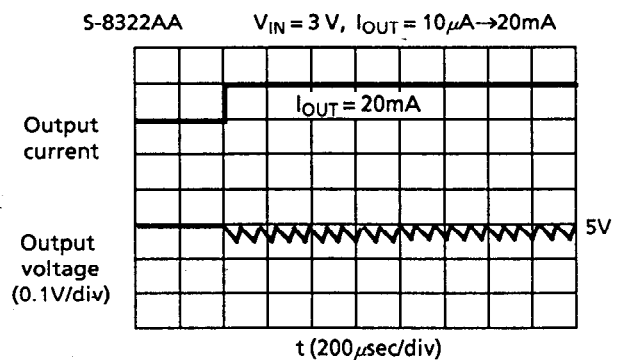
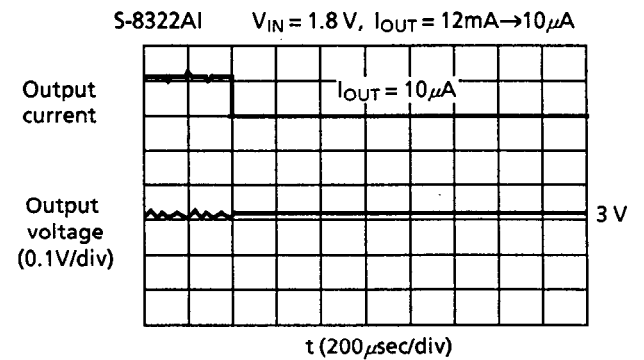
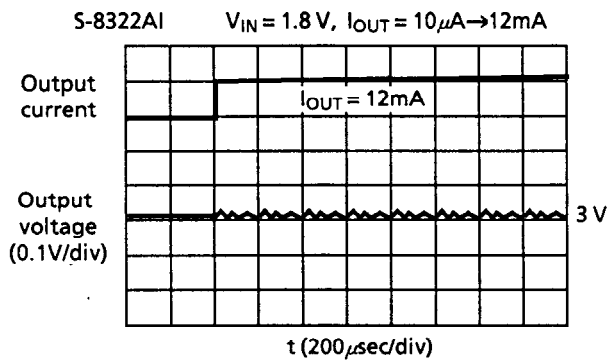
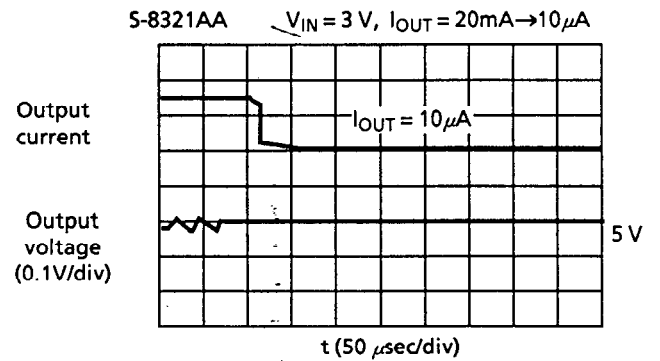
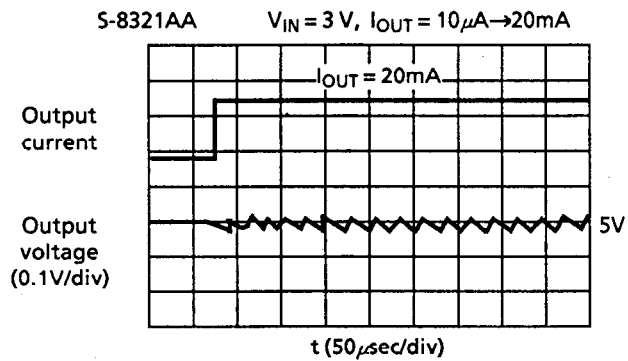
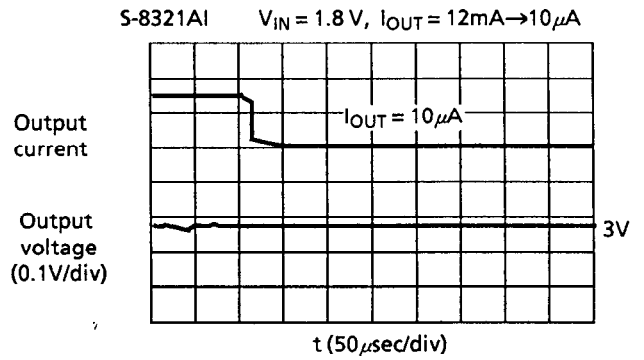
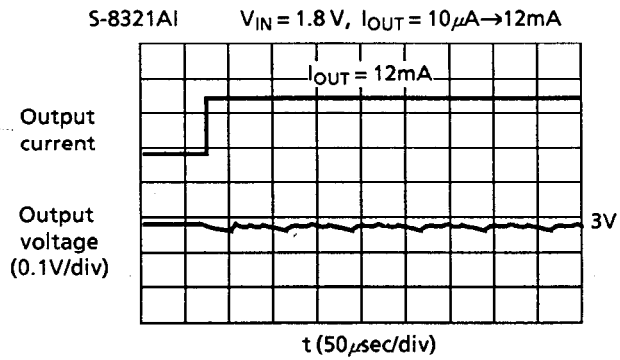

SMALL PACKAGE PFM CONTROL STEP-UP SWITCHING REGULATOR

S-8321/8322 Series

1.4 Shutdown pin response ($T_a = 25^\circ\text{C}$)

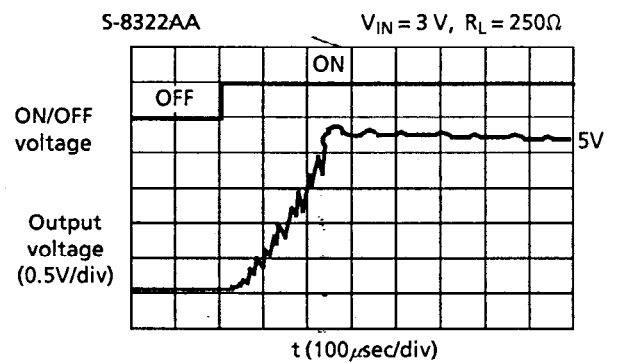
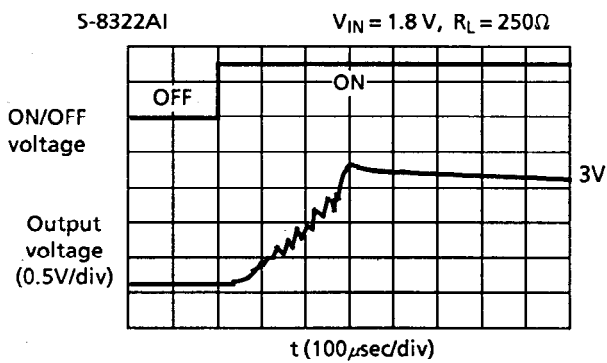
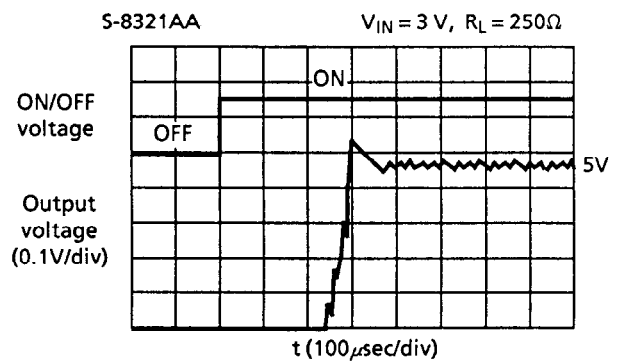
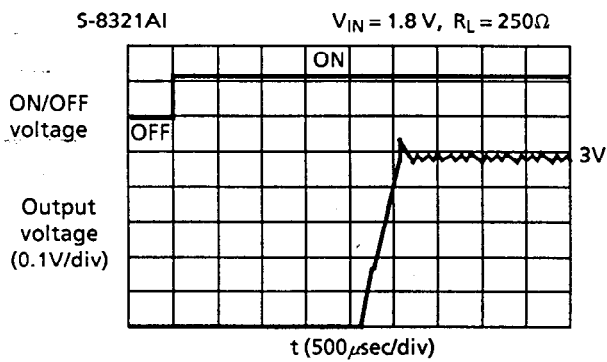

Reference Data (2)

The following are step-up characteristics when the coils shown in the following list are used

Evaluated coils:

Model	Manufacturer	Value	Max. DC resistance	Allowable current
CD54	Sumida Electric	22 μH	0.18 Ω	1110 mA
CD54	Sumida Electric	47 μH	0.37 Ω	720 mA
CD54	Sumida Electric	100 μH	0.7 Ω	520 mA
CD54	Sumida Electric	220 μH	1.57 Ω	350 mA
CP4LBM	Sumida Electric	100 μH	6.4 Ω	130 mA

[I] S-8321AI (Built-in, $V_{OUT} = 3\text{V}$)

1.1 CD54 (47 μH), $T_a = 25^\circ\text{C}$

(a) Input voltage - Output voltage (rise in input voltage)

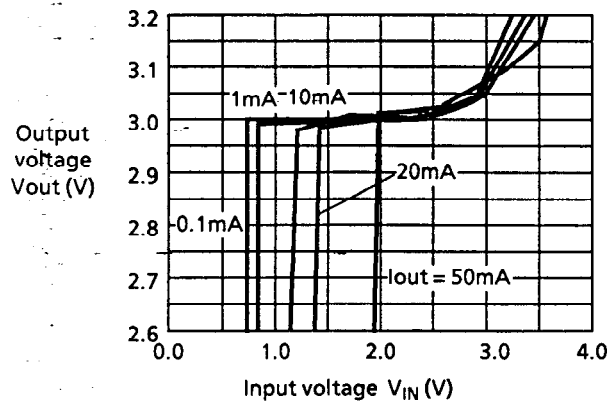

(b) Input voltage - Output voltage (fall in input voltage)

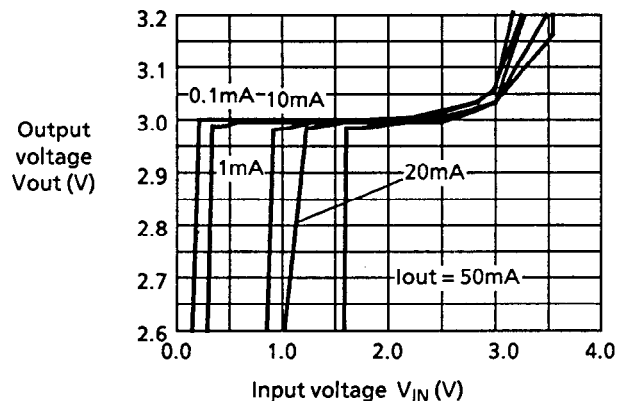

SMALL PACKAGE PFM CONTROL STEP-UP SWITCHING REGULATOR

S-8321/8322 Series

(c) Output current - Output voltage characteristics

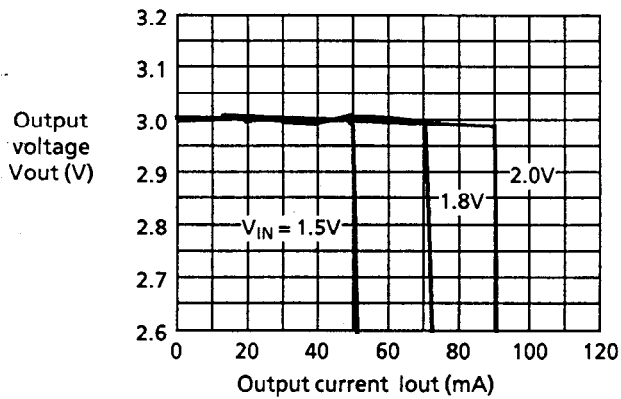

(d) Efficiency - Output current characteristics

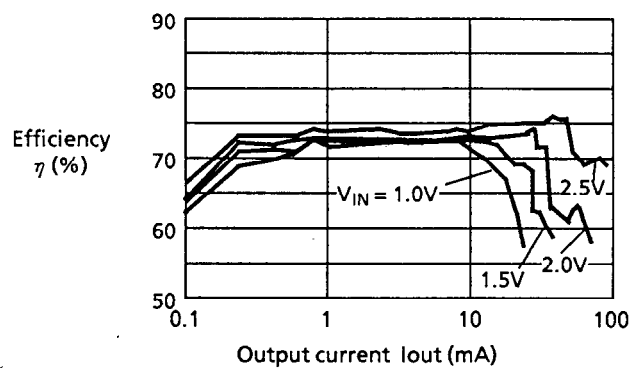

1.2 CD54 (100 μ H), Ta = 25°C

(a) Input voltage - Output voltage (rise in input voltage)

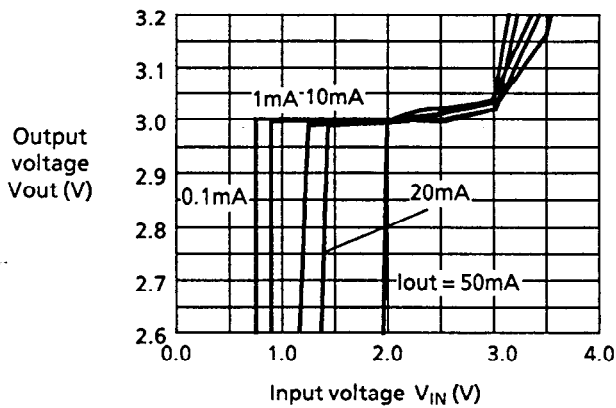

(b) Input voltage - Output voltage (fall in input voltage)

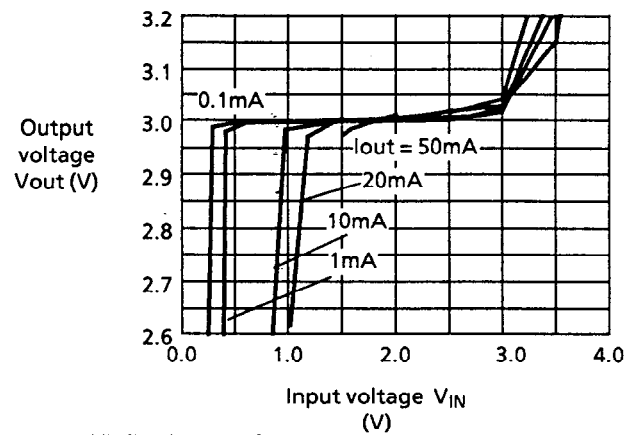

(c) Output current - Output voltage characteristics

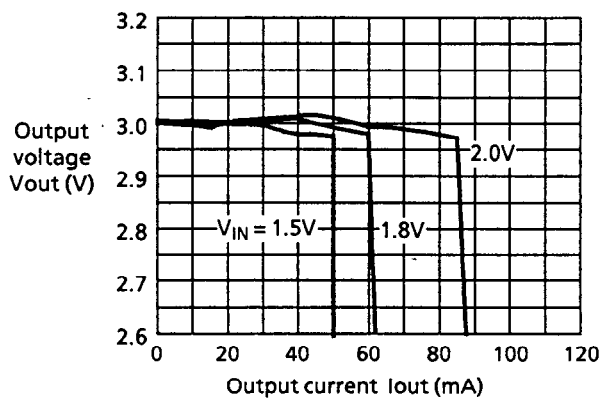

(d) Efficiency - Output current characteristics

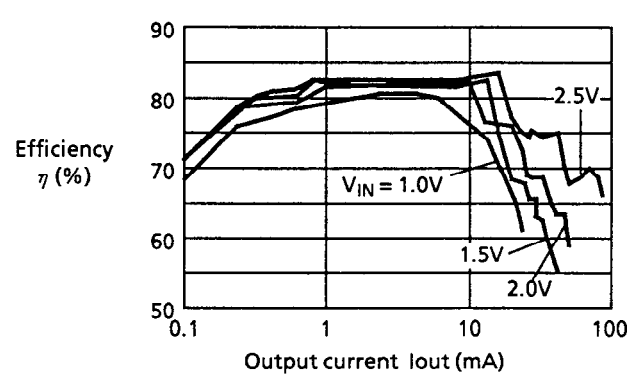

1.3 CP4LBM (100 μ H), Ta = 25°C

(a) Input voltage - Output voltage (rise in input voltage)

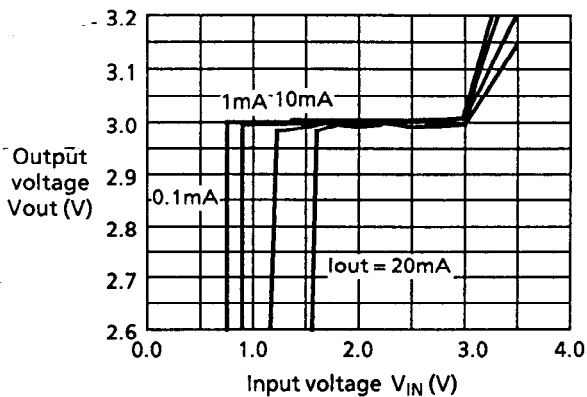

(b) Input voltage - Output voltage (fall in input voltage)

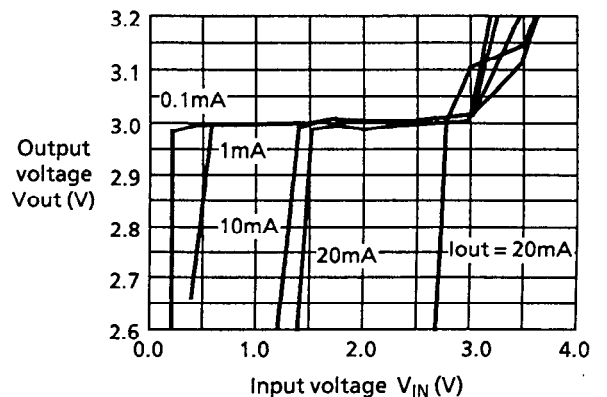

SMALL PACKAGE PFM CONTROL STEP-UP SWITCHING REGULATOR
S-8321/8322 Series

(c) Output current - Output voltage characteristics

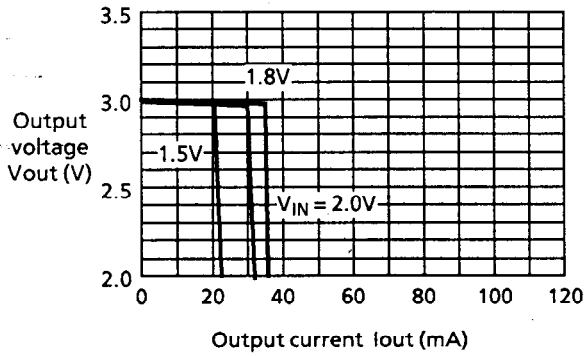

(d) Efficiency - Output current characteristics

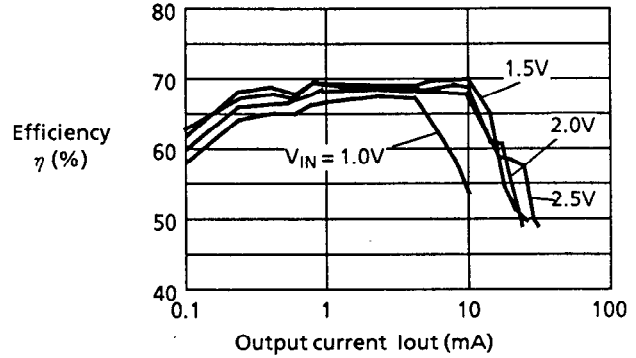

[II] S-8321AA (Built-in, $V_{out} = 5V$)

1.1 CD54 (100 μ H), $T_a = 25^\circ C$

(a) Input voltage - Output voltage (rise in input voltage)

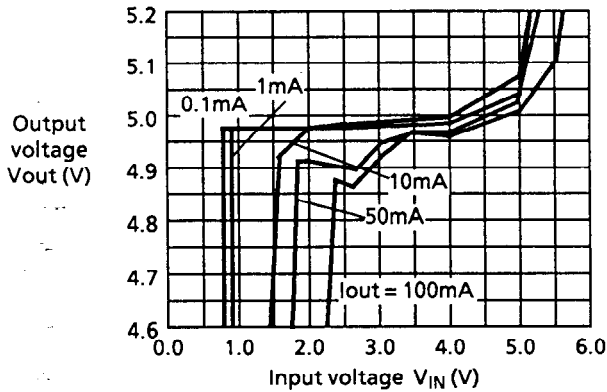

(b) Input voltage - Output voltage (fall in input voltage)

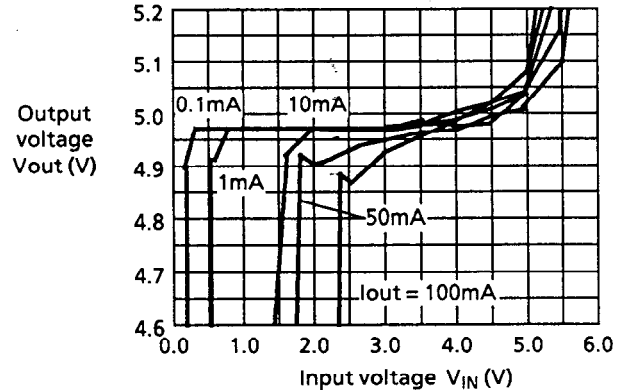

(c) Output current - Output voltage characteristics

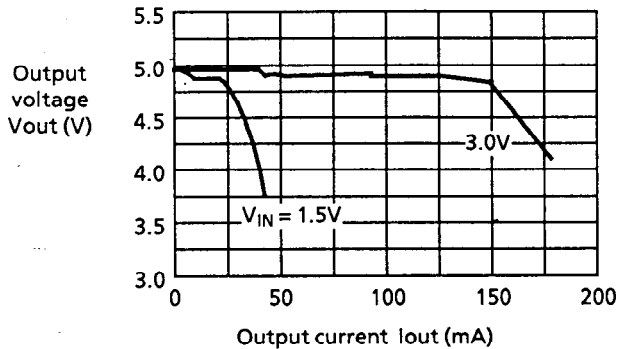

(d) Efficiency - Output current characteristics

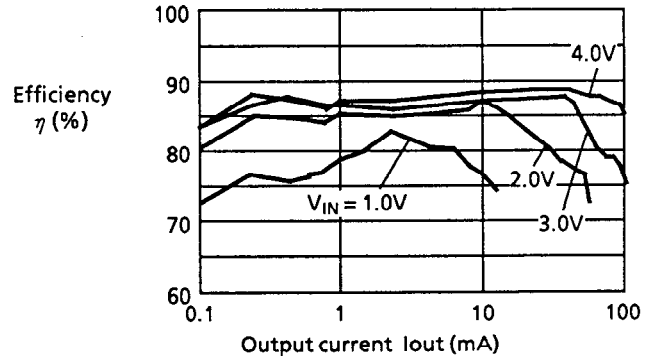

1.2 CD54 (220 μ H), $T_a = 25^\circ C$

(a) Input voltage - Output voltage (rise in input voltage)

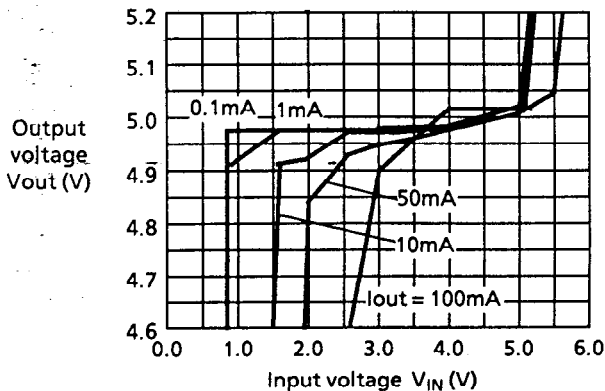

(b) Input voltage - Output voltage (fall in input voltage)

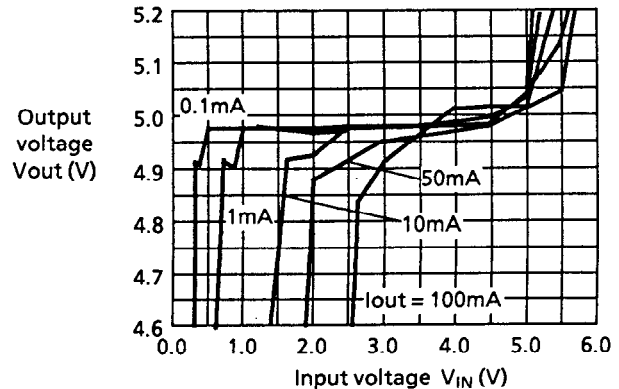

(c) Output current - Output voltage characteristics

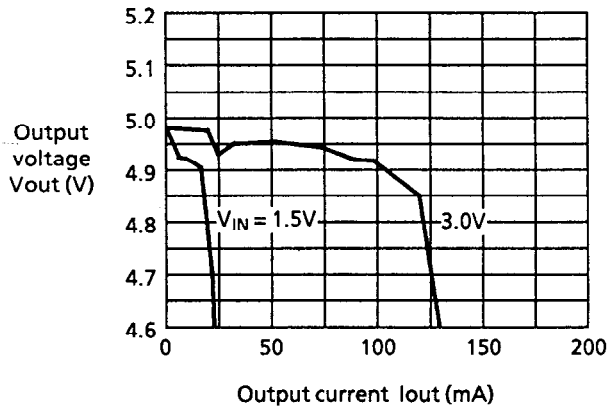

(d) Efficiency - Output current characteristics

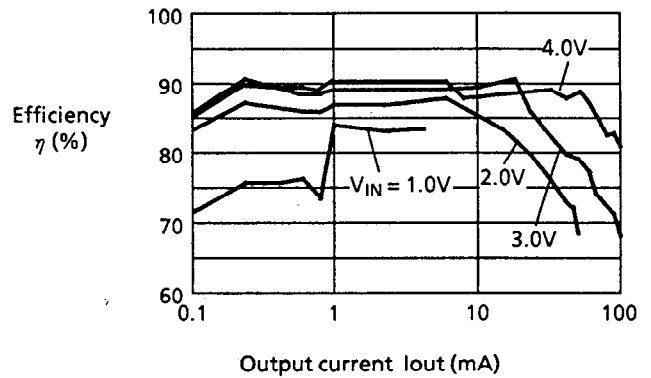

1.3 CP4LBM (100 μ H), Ta = 25°C

(a) Input voltage - Output voltage (rise in input voltage)

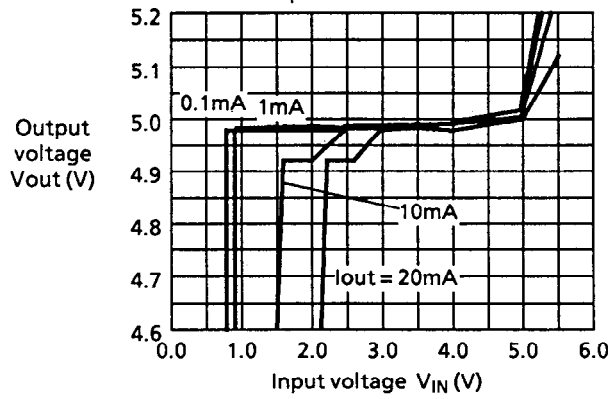

(b) Input voltage - Output voltage (fall in input voltage)

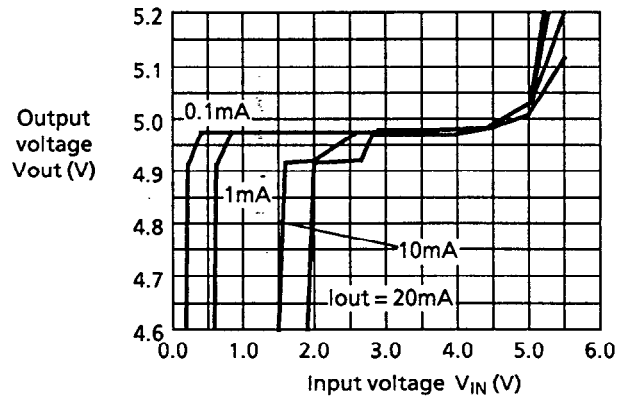

(c) Output current - Output voltage characteristics

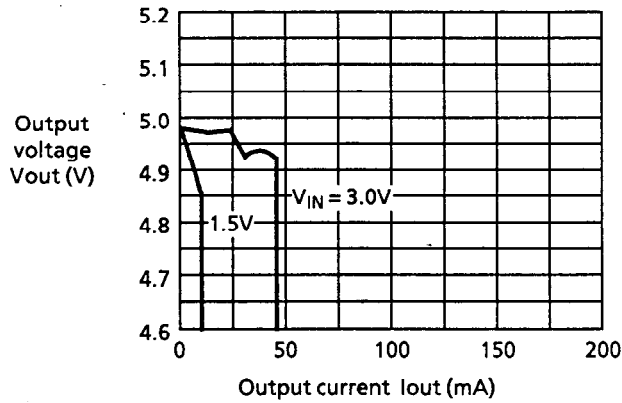

(d) Efficiency - Output current characteristics

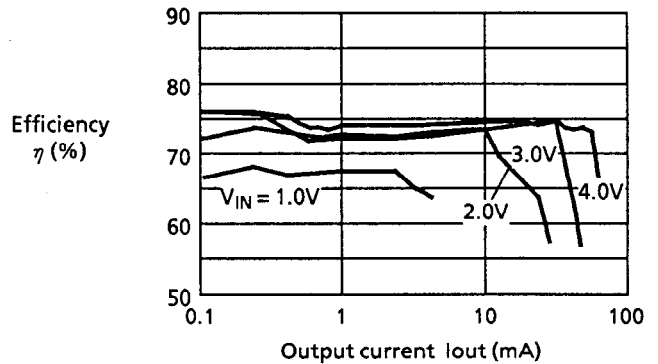

SMALL PACKAGE PFM CONTROL STEP-UP SWITCHING REGULATOR

S-8321/8322 Series

[III] S-8322AI (External parts, $V_{out} = 3V$)

1.1 CD54 (22 μ H), $T_a = 25^\circ C$

(a) Input voltage - Output voltage (rise in input voltage)

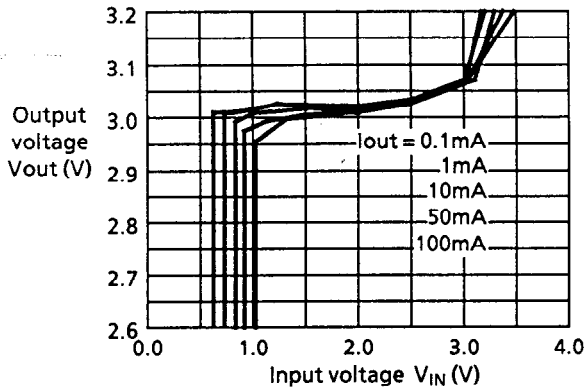

(b) Input voltage - Output voltage (fall in input voltage)

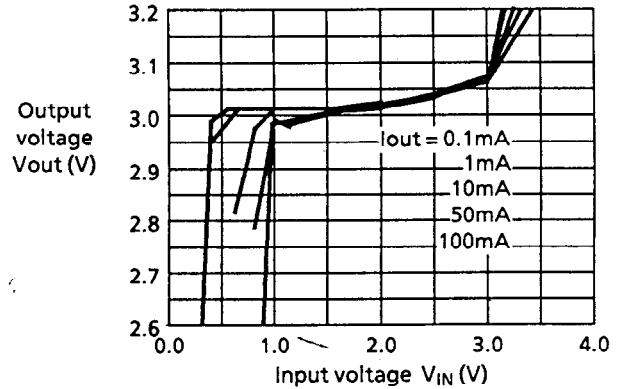

(c) Output current - Output voltage characteristics

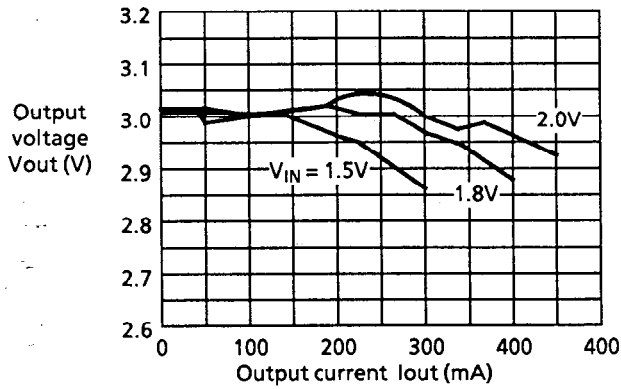

(d) Efficiency - Output voltage characteristics

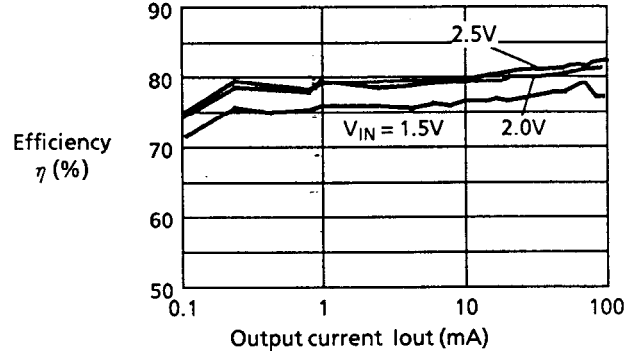

1.2 CD54 (100 μ H), $T_a = 25^\circ C$

(a) Input voltage - Output voltage (rise in input voltage)

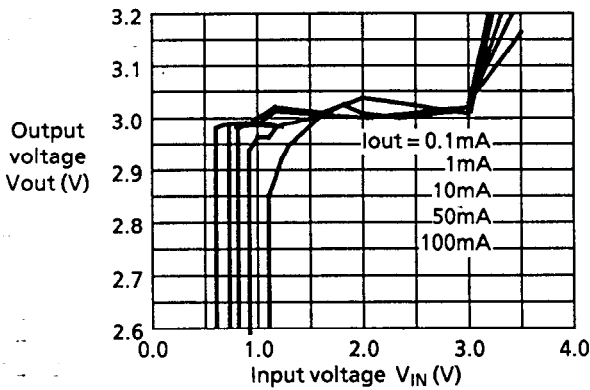

(b) Input voltage - Output voltage (fall in input voltage)

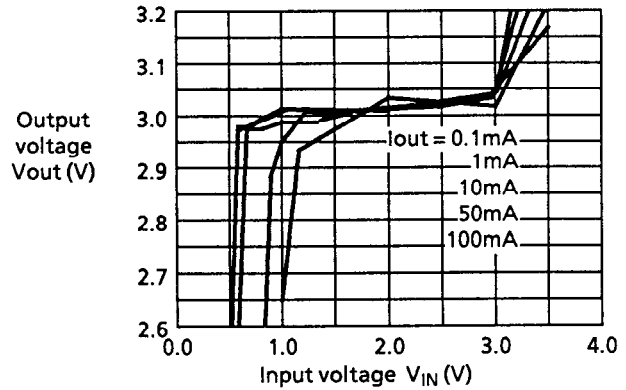

(c) Output current - Output voltage characteristics

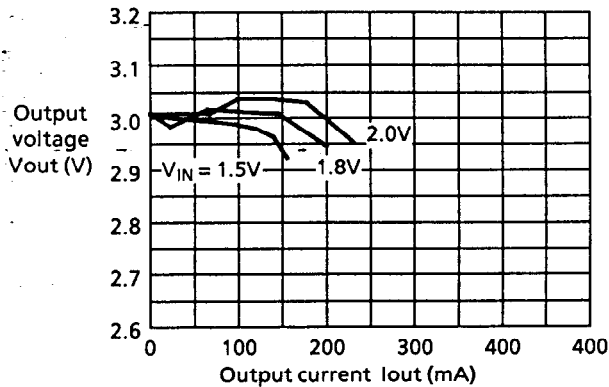

(d) Efficiency - Output voltage characteristics

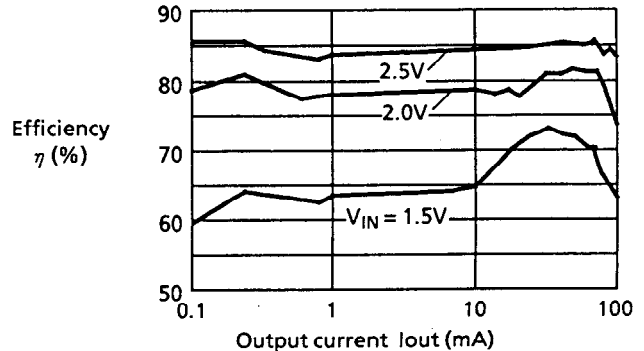

[IV] S-8322AA (External parts, $V_{out} = 5V$)

1.1 CD54 (22 μ H), $T_a = 25^\circ C$

(a) Input voltage - Output voltage (rise in input voltage)

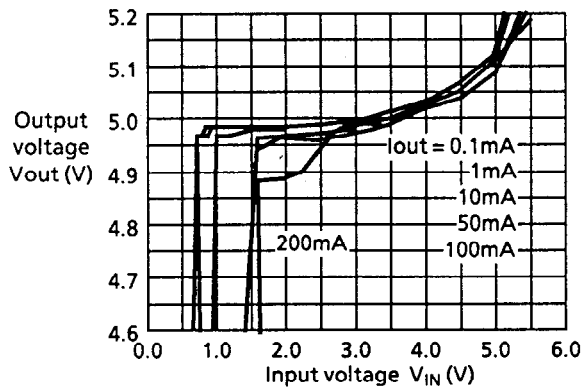

(b) Input voltage - Output voltage (fall in input voltage)

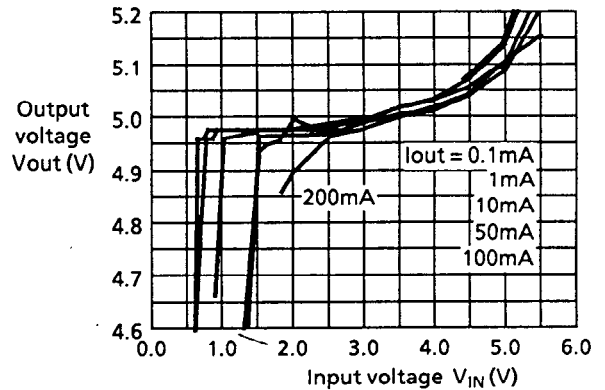

Output current - Output voltage characteristics

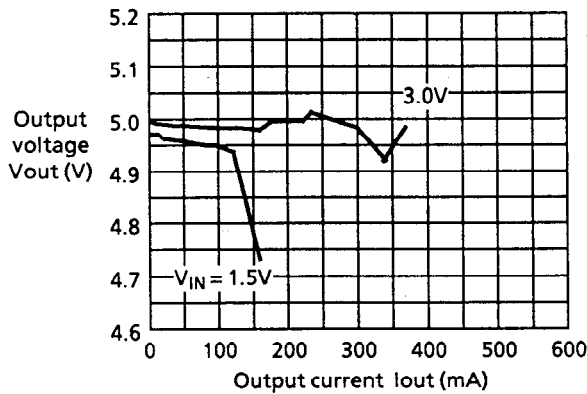

(d) Efficiency - Output voltage characteristics

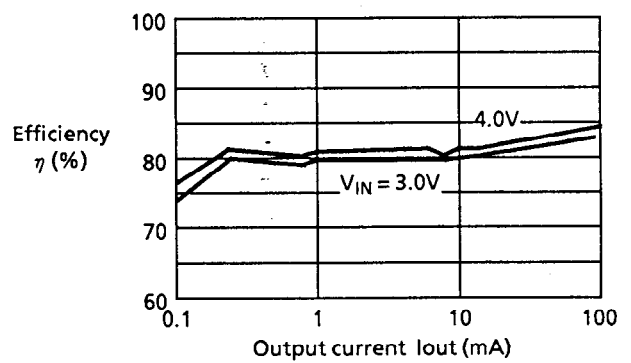

1.2 CD54 (100 μ H), $T_a = 25^\circ C$

(a) Input voltage - Output voltage (rise in input voltage)

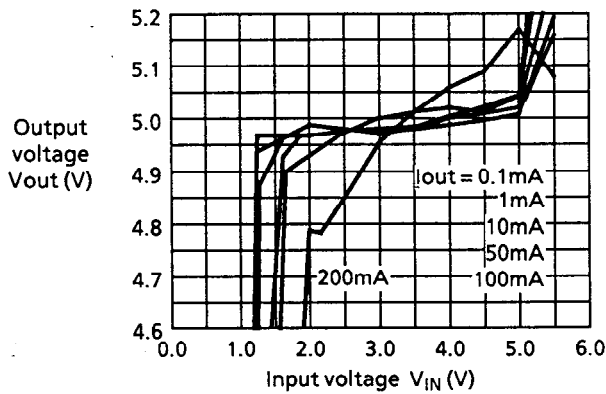

(b) Input voltage - Output voltage (fall in input voltage)

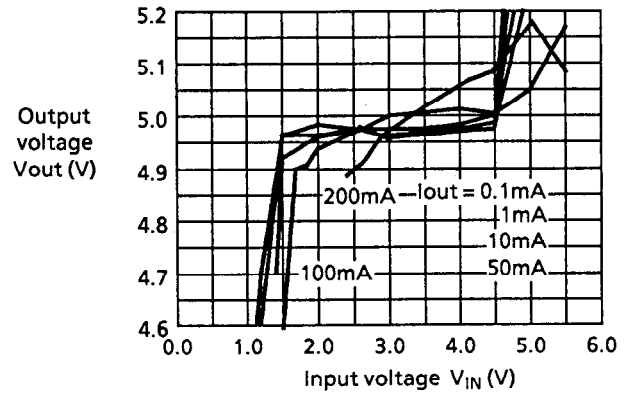

(c) Output current - Output voltage characteristics

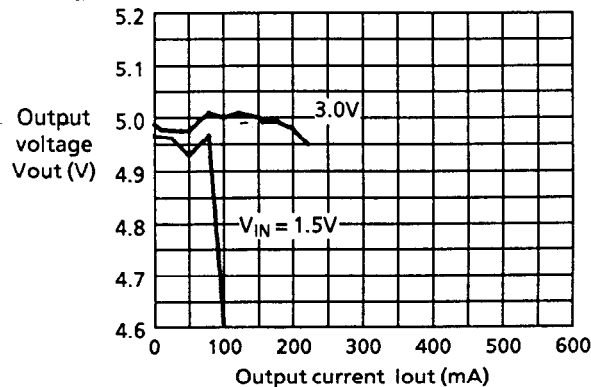

(d) Efficiency - Output voltage characteristics

