

Silicon PNP Power Transistors

2SB553

DESCRIPTION

- With TO-220C package
- Complement to type 2SD553
- Low collector saturation voltage

APPLICATIONS

- High current switching applications
- Power amplifier applications

PINNING

PIN	DESCRIPTION
1	Emitter
2	Collector;connected to mounting base
3	Base

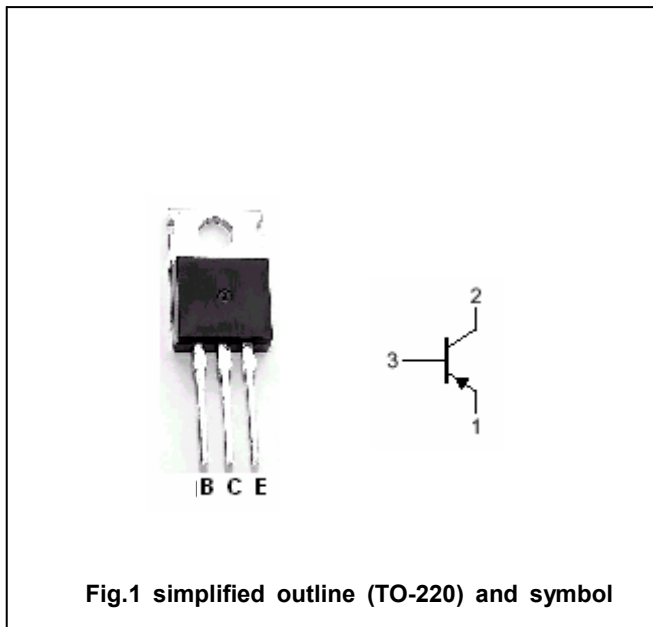

Absolute maximum ratings(Ta=25℃)

SYMBOL	PARAMETER	CONDITIONS	VALUE	UNIT
V _{CBO}	Collector-base voltage	Open emitter	-70	V
V _{CEO}	Collector-emitter voltage	Open base	-50	V
V _{EBO}	Emitter-base voltage	Open collector	-5	V
I _C	Collector current (DC)		-7	A
P _C	Collector dissipation	T _a =25℃	1.5	W
		T _C =25℃	40	
T _j	Junction temperature		150	℃
T _{stg}	Storage temperature		-50~150	℃

Silicon PNP Power Transistors

2SB553

CHARACTERISTICS

T_j=25°C unless otherwise specified

SYMBOL	PARAMETER	CONDITIONS	MIN	TYP.	MAX	UNIT
V _{(BR)CEO}	Collector-emitter breakdown voltage	I _C =-50mA; I _B =0	-50			V
V _{CEsat}	Collector-emitter saturation voltage	I _C =-4A; I _B =-0.4A		-0.2	-0.4	V
V _{BEsat}	Base-emitter saturation voltage	I _C =-4A; I _B =-0.4A		-0.9	-1.2	V
I _{CBO}	Collector cut-off current	V _{CB} =-70V; I _E =0			-30	μA
I _{EBO}	Emitter cut-off current	V _{EB} =-5V; I _C =0			-50	μA
h _{FE-1}	DC current gain	I _C =-1A; V _{CE} =-1V	70		240	
h _{FE-2}	DC current gain	I _C =-4A; V _{CE} =-1V	30			
C _{OB}	Collector output capacitance	I _E =0; V _{CB} =-10V; f=1MHz		250		pF
f _T	Transition frequency	I _C =-1A; V _{CE} =-4V		10		MHz

Switching times

t _{on}	Turn-on time	I _{B1} =-I _{B2} =-0.3A; V _{CC} ≈-30V R _L =10Ω		0.2		μs
t _s	Storage time			2.5		μs
t _f	Fall time			0.5		μs

◆ h_{FE-1} Classifications

O	Y
70-140	120-240

Silicon PNP Power Transistors

2SB553

PACKAGE OUTLINE

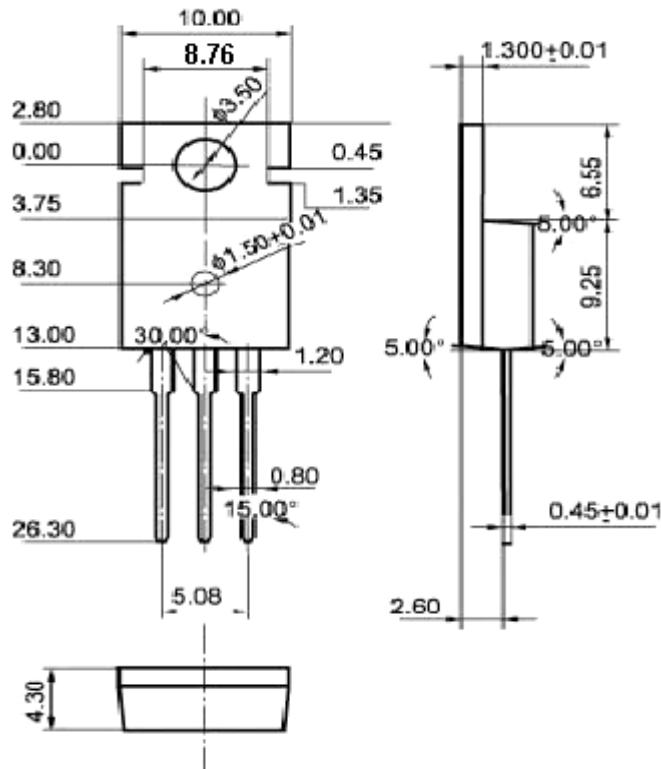

Fig.2 Outline dimensions (unindicated tolerance: ± 0.10 mm)

Silicon PNP Power Transistors

2SB553

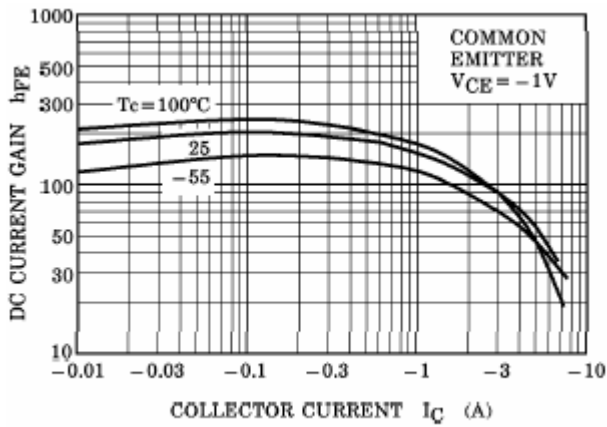

Fig.3 DC current Gain

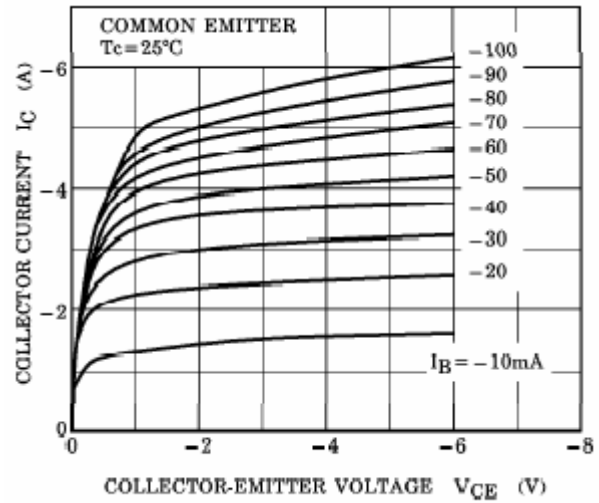

Fig.4 Static Characteristic

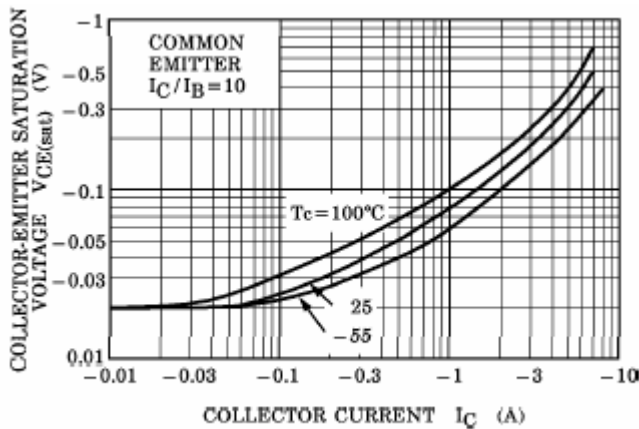

Fig.5 Collector-Emitter Saturation Voltage

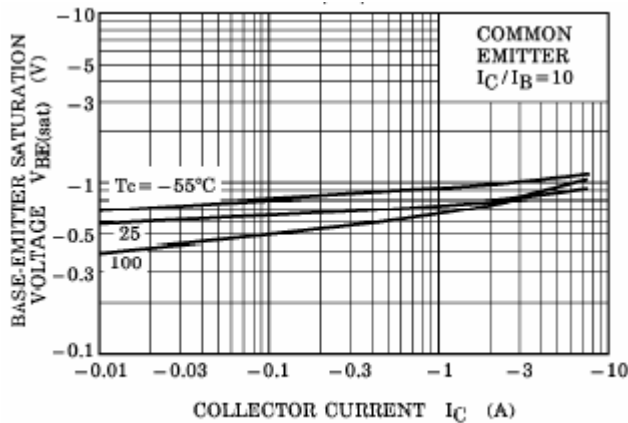

Fig.6 Base-Emitter Saturation Voltage

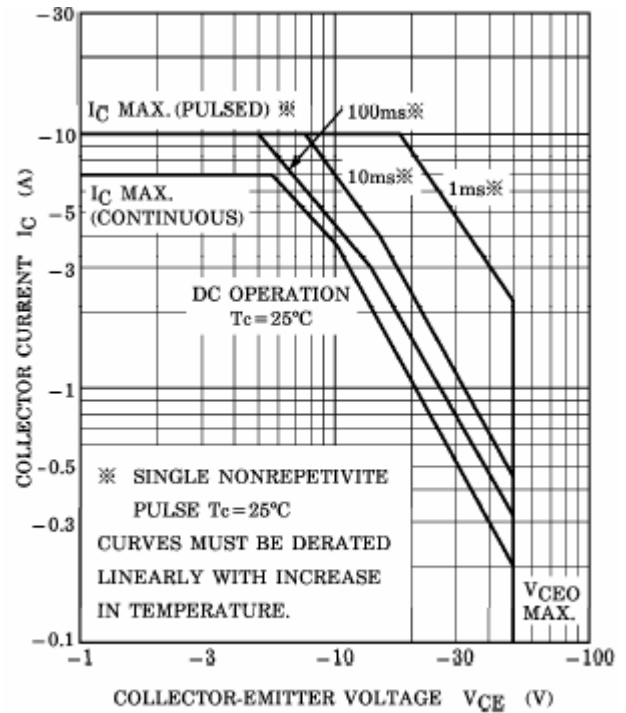

Fig.7 Safe Operating Area