

LOW DROPOUT VOLTAGE REGULATOR

■ GENERAL DESCRIPTION

The NJM2865/66 is a 100mA output low dropout voltage regulator with ON/OFF control.

Advanced Bipolar technology achieves low noise, high ripple rejection and low quiescent current.

Small packaging, 1 μ F small decoupling capacitor, built-in noise bypass capacitor make the NJM2865/66 suitable for space conscious applications.

■ PACKAGE OUTLINE



NJM2865F3

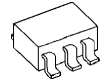

NJM2865F/66F

■ FEATURES

- High Ripple Rejection 75dB typ. (f=1kHz Vo=3V Version)
- Output Noise Voltage Vno=45 μ Vrms typ.
- Output capacitor with 1.0 μ F ceramic capacitor (Vo \geq 2.7V)
- Output Current Io(max.)=100mA
- High Precision Output Vo \pm 1.0%
- Low Dropout Voltage 0.10V typ. (Io=60mA)
- Input Voltage Range +2.3V ~ +14V (Vo \leq 2.0 Version)
- ON/OFF Control (Active High)
- Internal Short Circuit Current Limit
- Internal Thermal Overload Protection
- Bipolar Technology
- Package Outline SC88A (NJM2865F3), SOT-23-5 (NJM2865F/66F)

■ PIN CONFIGURATION

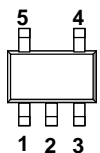

1. CONTROL
2. GND
3. NC
4. V_{OUT}
5. V_{IN}

NJM2865F3 / NJM2865F

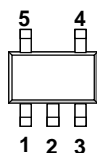

1. V_{IN}
2. GND
3. CONTROL
4. NC
5. V_{OUT}

NJM2866F

■ EQUIVALENT CIRCUIT

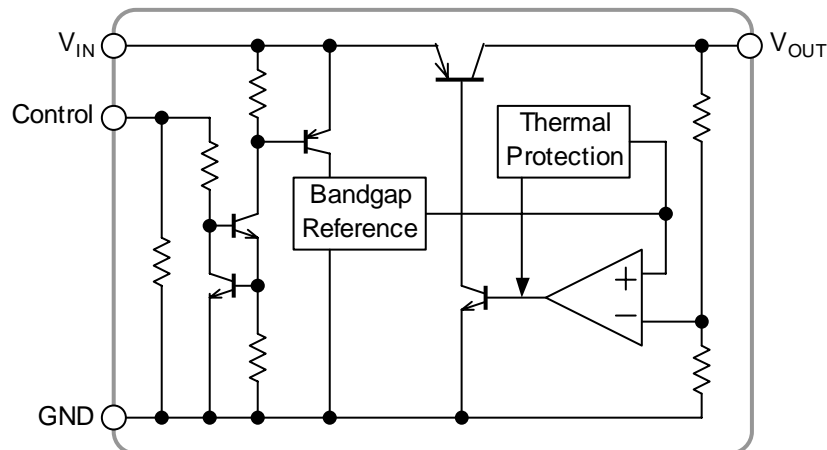

NJM2865/66

■ OUTPUT VOLTAGE RANK LIST

Device Name	V _{OUT}	Device Name	V _{OUT}	Device Name	V _{OUT}
NJM2865F3-/F15	1.5V	NJM2865F3-/F29	2.9V	NJM2865F3-/F36	3.6V
NJM2865F3-/F18	1.8V	NJM2865F3-/F03	3.0V	NJM2865F3-/F38	3.8V
NJM2865F3-/F21	2.1V	NJM2865F3-/F31	3.1V	NJM2865F3-/F46	4.6V
NJM2865F3-/F24	2.4V	NJM2865F3-/F32	3.2V	NJM2865F3-/F48	4.8V
NJM2865F3-/F25	2.5V	NJM2865F3-/F33	3.3V	NJM2865F3-/F05	5.0V
NJM2865F3-/F26	2.6V	NJM2865F3-/F34	3.4V		
NJM2865F3-/F28	2.8V	NJM2865F3-/F35	3.5V		

Device Name	V _{OUT}	Device Name	V _{OUT}	Device Name	V _{OUT}
NJM2866F15	1.5V	NJM2866F29	2.9V	NJM2866F36	3.6V
NJM2866F18	1.8V	NJM2866F03	3.0V	NJM2866F38	3.8V
NJM2866F21	2.1V	NJM2866F31	3.1V	NJM2866F46	4.6V
NJM2866F24	2.4V	NJM2866F32	3.2V	NJM2866F48	4.8V
NJM2866F25	2.5V	NJM2866F33	3.3V	NJM2866F05	5.0V
NJM2866F26	2.6V	NJM2866F34	3.4V		
NJM2866F28	2.8V	NJM2866F35	3.5V		

■ ABSOLUTE MAXIMUM RATINGS (Ta=25°C)

PARAMETER	SYMBOL	RATINGS		UNIT
Input Voltage	V _{IN}	+14		V
Control Voltage	V _{CONT}	+14(*1)		V
Power Dissipation	P _D	SC88A	250(*2)	mW
		SOT-23-5	200(*3)	
			350(*2)	
Operating Temperature	Topr	-40~+85		°C
Storage Temperature	Tstg	-40~+125		°C

(*1): When input voltage is less than +14V, the absolute maximum control voltage is equal to the input voltage.

(*2): Mounted on glass epoxy board based on EIA/JEDEC. (114.3x76.2x1.6mm: 2Layers)

(*3): Device itself.

■ Operating voltage

V_{IN}=+2.3V ~ +14.0V (In case of Vo<2.1V)

■ ELECTRICAL CHARACTERISTICS (Vo≥2.0V version: V_{IN}=Vo+1V, C_{IN}=0.1μF, Co=1.0μF: Vo≥2.7V (Co=2.2μF: Vo≤2.6V), Ta=25°C)

PARAMETER	SYMBOL	TEST CONDITION	MIN.	TYP.	MAX.	UNIT
Output Voltage	Vo	I _o =30mA	-1.0%	-	+1.0%	V
Quiescent Current	I _Q	I _o =0mA, expect I _{cont}	-	120	180	μA
Quiescent Current at Control OFF	I _{Q(OFF)}	V _{CONT} =0V	-	-	100	nA
Output Current	I _o	Vo=0.3V	100	130	-	mA
Line Regulation	ΔVo/ΔV _{IN}	V _{IN} =Vo+1V ~ Vo+6V, I _o =30mA	-	-	0.10	%/V
Load Regulation	ΔVo/ΔI _o	I _o =0 ~ 60mA	-	-	0.03	%/mA
Dropout Voltage	ΔV _{L.O}	I _o =60mA	-	0.10	0.18	V
Ripple Rejection	RR	e _{in} =200mVrms, f=1kHz, I _o =10mA, Vo=3V Version	-	75	-	dB
Average Temperature Coefficient of Output Voltage	ΔVo/ΔTa	Ta=0 ~ 85°C, I _o =10mA	-	± 50	-	ppm/°C
Output Noise Voltage	V _{NO}	f=10Hz ~ 80kHz, I _o =10mA, Vo=3V Version	-	45	-	μVrms
Control Voltage for ON-state	V _{CONT(ON)}		1.6	-	-	V
Control Voltage for OFF-state	V _{CONT(OFF)}		-	-	0.6	V

■ ELECTRICAL CHARACTERISTICS ($V_O \leq 2.0V$ version: $V_{IN} = V_O + 1V$, $C_{IN} = 0.1\mu F$, $C_O = 2.2\mu F$, $T_a = 25^\circ C$)

PARAMETER	SYMBOL	TEST CONDITION	MIN.	TYP.	MAX.	UNIT
Output Voltage	V_O	$I_O = 30mA$	-1.0%	-	+1.0%	V
Quiescent Current	I_Q	$I_O = 0mA$, expect I_{cont}	-	120	180	μA
Quiescent Current at Control OFF	$I_{Q(OFF)}$	$V_{CONT} = 0V$	-	-	100	nA
Output Current	I_O	$V_O = 0.3V$	100	130	-	mA
Line Regulation	$\Delta V_O / \Delta V_{IN}$	$V_{IN} = V_O + 1V \sim V_O + 6V$, $I_O = 30mA$	-	-	0.10	%/V
Load Regulation	$\Delta V_O / \Delta I_O$	$I_O = 0 \sim 60mA$	-	-	0.03	%/mA
Ripple Rejection	RR	$e_{in} = 200mV_{rms}$, $f = 1kHz$, $I_O = 10mA$, $V_O = 1.8V$ Version	-	80	-	dB
Average Temperature Coefficient of Output Voltage	$\Delta V_O / \Delta T_a$	$T_a = 0 \sim 85^\circ C$, $I_O = 10mA$	-	± 50	-	ppm/ $^\circ C$
Output Noise Voltage	V_{NO}	$f = 10Hz \sim 80kHz$, $I_O = 10mA$, $V_O = 1.8V$ Version	-	27	-	μV_{rms}
Control Voltage for ON-state	$V_{CONT(ON)}$		1.6	-	-	V
Control Voltage for OFF-state	$V_{CONT(OFF)}$		-	-	0.6	V

(*4): The above specification is a common specification for all output voltages.

Therefore, it may be different from the individual specification for a specific output voltage.

■ TEST CIRCUIT

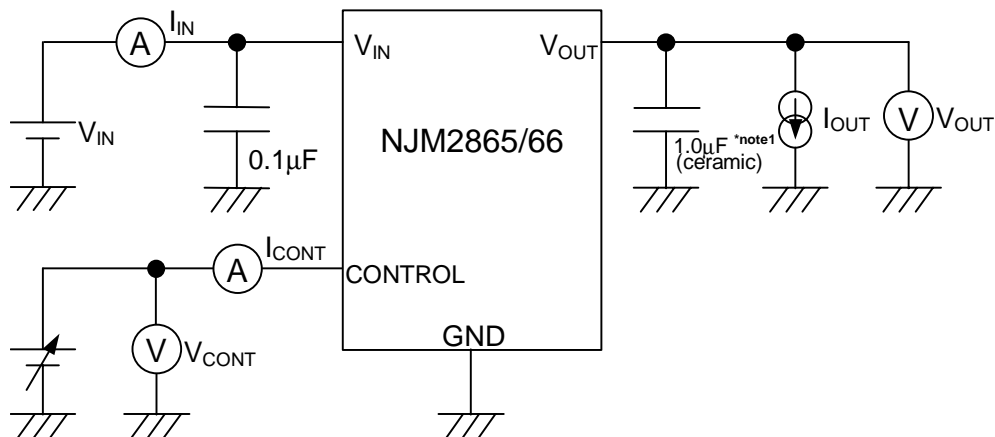

*note1 1.6V < V_O < 2.6V version: $C_O = 2.2\mu F$ (ceramic)
 $V_O \leq 1.6V$ version: $4.7\mu F$ (ceramic)

NJM2865/66

■ TYPICAL APPLICATION

① In the case where ON/OFF Control is not required:

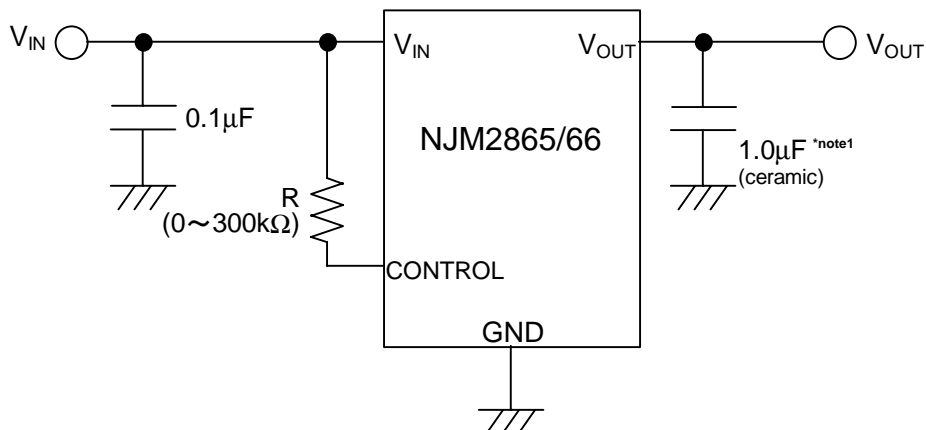

*note1 1.6V < V_o ≤ 2.6V version: C_o = 2.2µF (ceramic)
 V_o ≤ 1.6V version: 4.7µF (ceramic)

Connect control terminal to V_{IN} terminal

The quiescent current can be reduced by using a resistance “R”. Instead, it increases the minimum operating voltage. For further information, please refer to Figure “Output Voltage vs. Control Voltage”.

② In use of ON/OFF CONTROL:

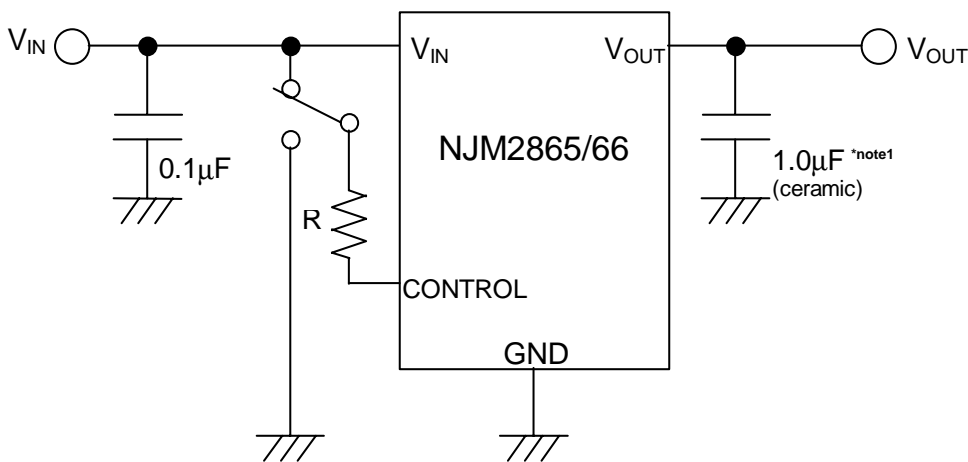

*note1 1.6V < V_o ≤ 2.6V version: C_o = 2.2µF (ceramic)
 V_o ≤ 1.6V version: 4.7µF (ceramic)

State of control terminal:

- “H” → output is enabled.
- “L” or “open” → output is disabled.

POWER DISSIPATION vs. AMBIENT TEMPERATURE

NJM2865/66F Power Dissipation
 (Topr=-40~+85°C, Tj=125°C, PD=200mW (Ta ≤ 25°C))

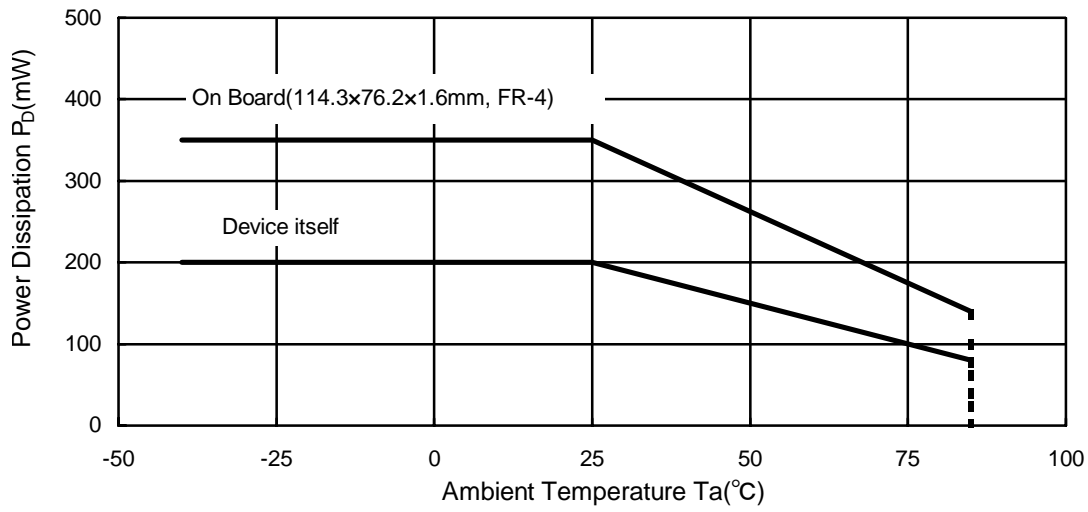

NJM2865F3 Power Dissipation
 (Topr=-40~+85°C, Tj=125°C)

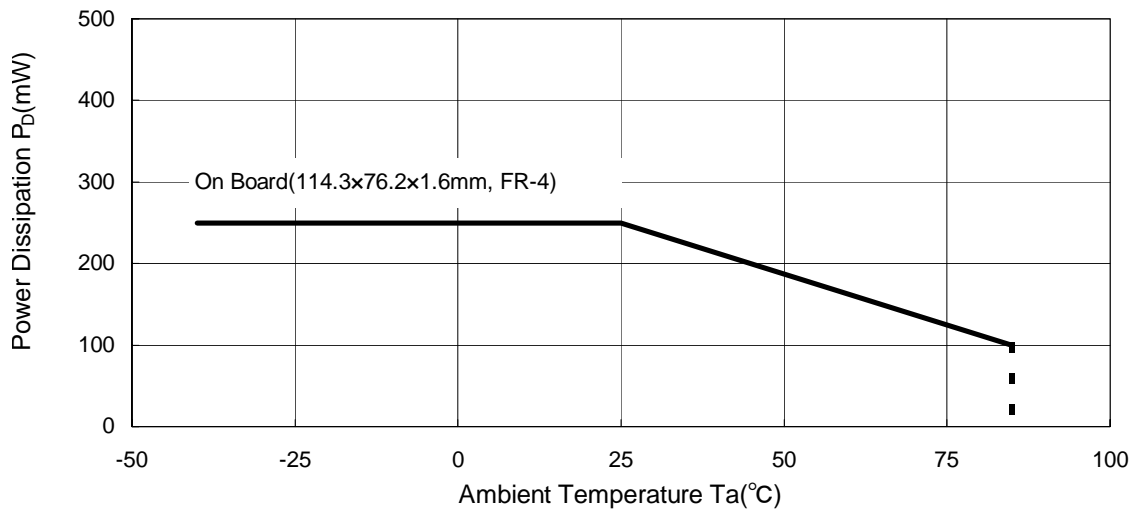

NJM2865/66

ELECTRICAL CHARACTERISTICS

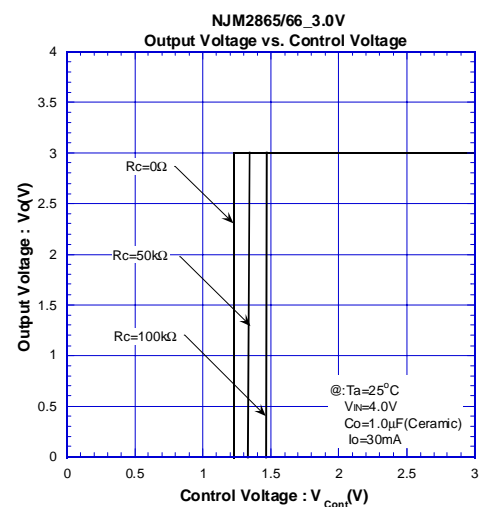
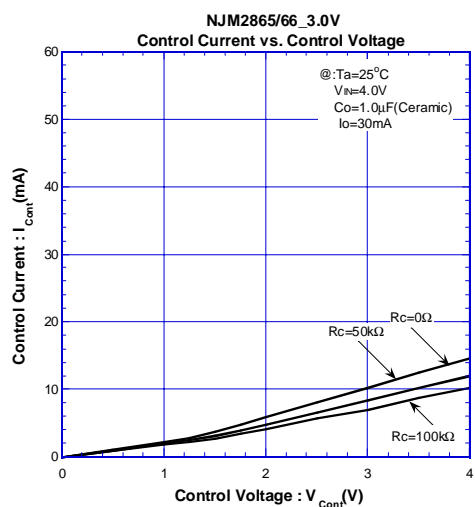
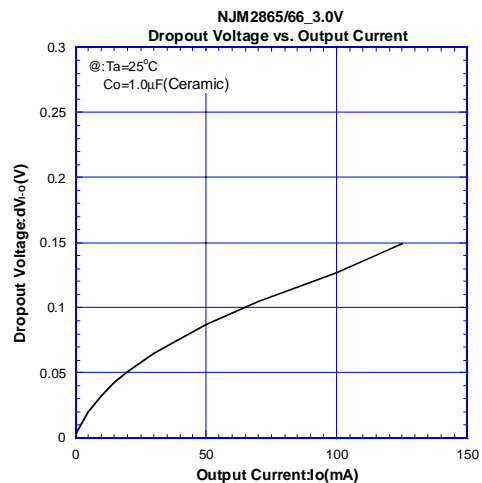
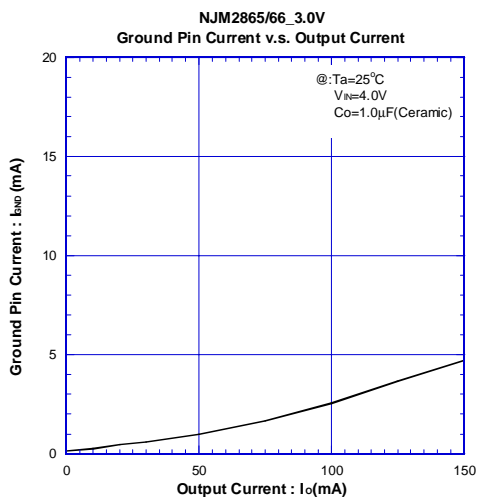
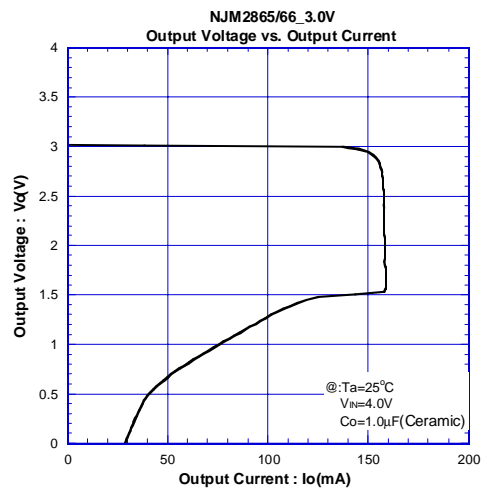
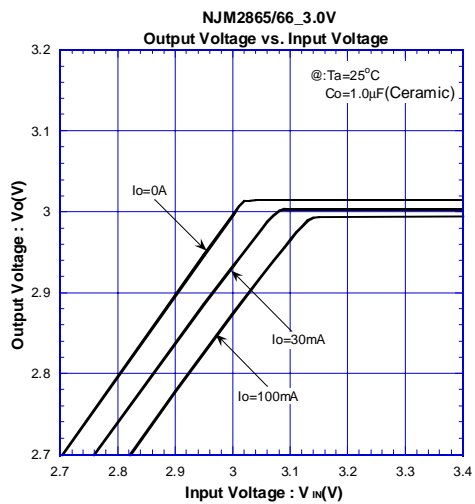

ELECTRICAL CHARACTERISTICS

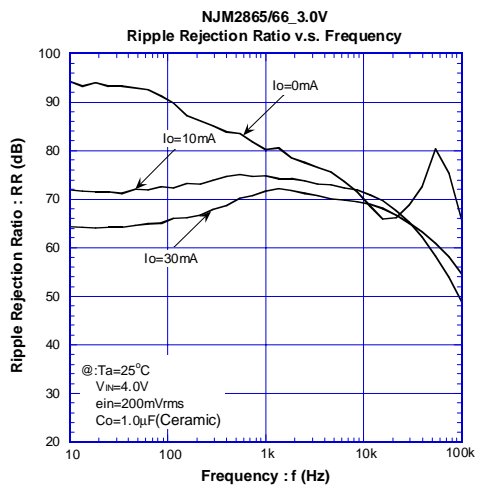
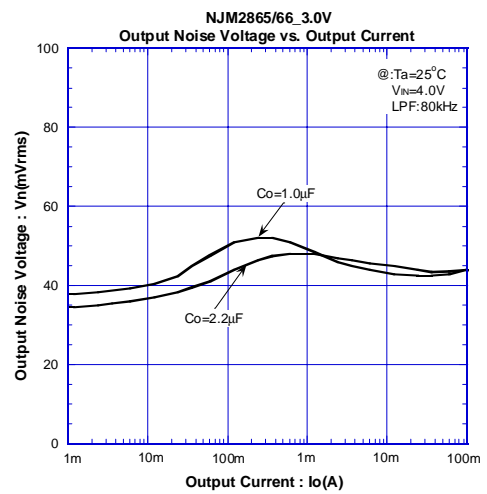
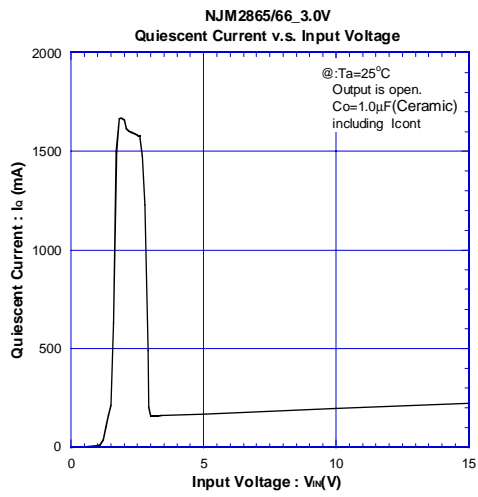
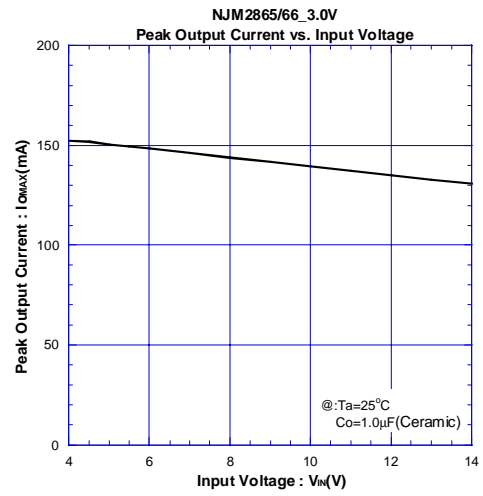
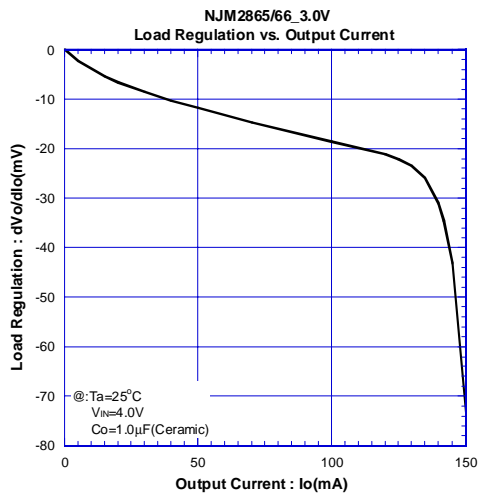

NJM2865/66

ELECTRICAL CHARACTERISTICS

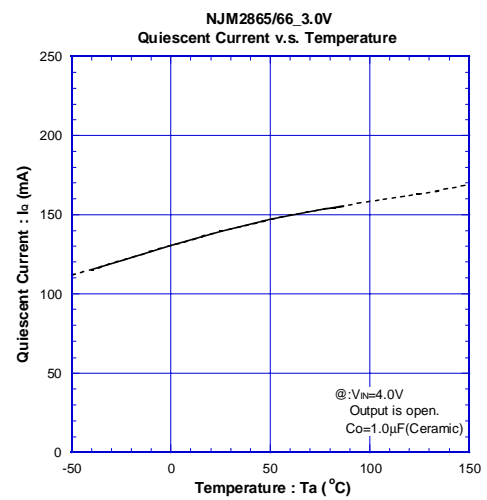
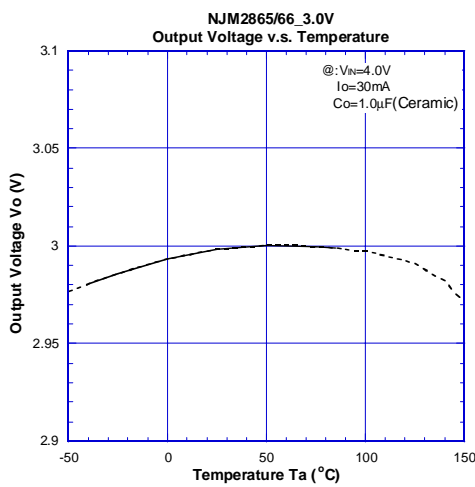
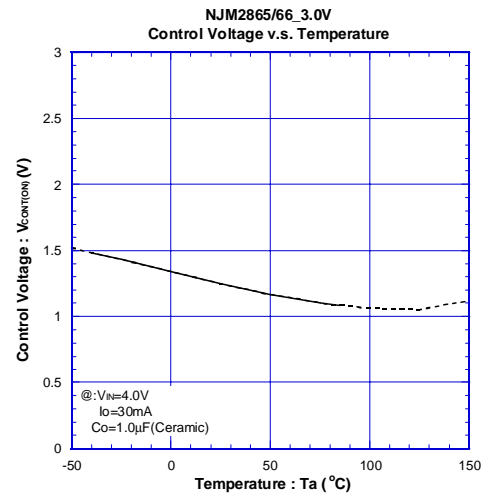
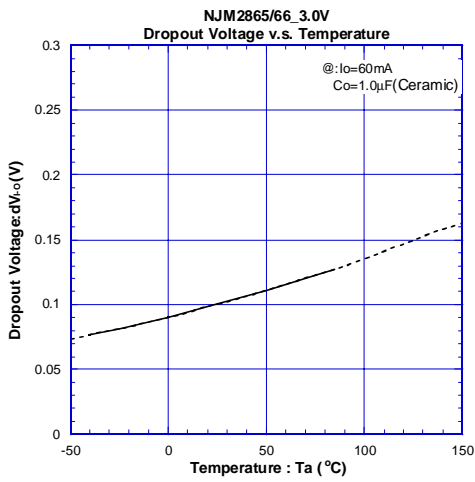
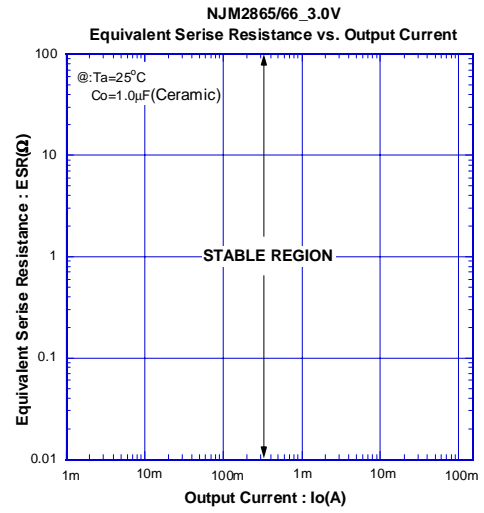
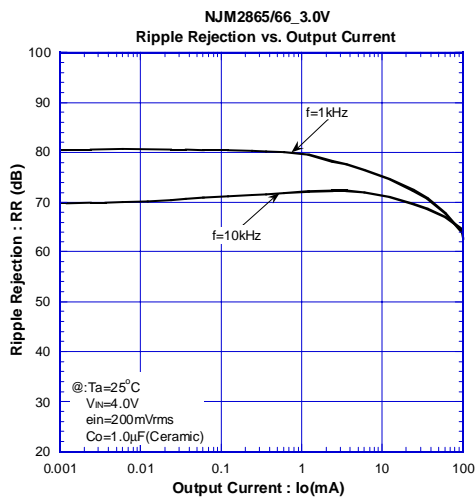

ELECTRICAL CHARACTERISTICS

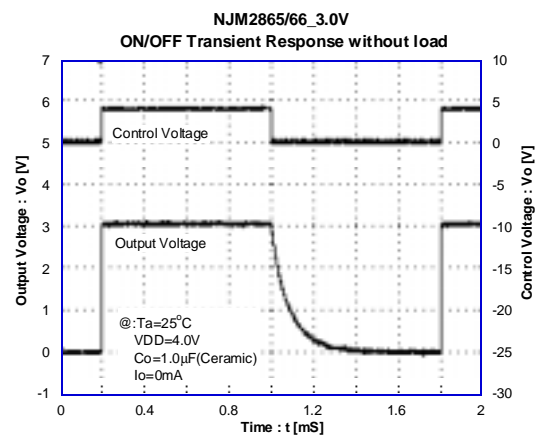
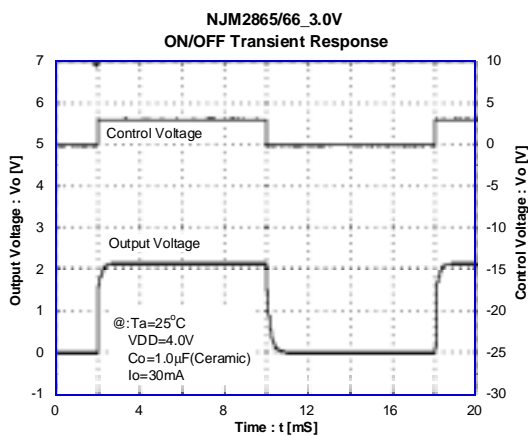
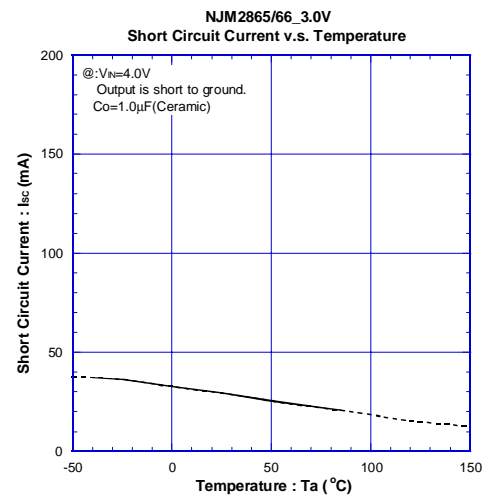
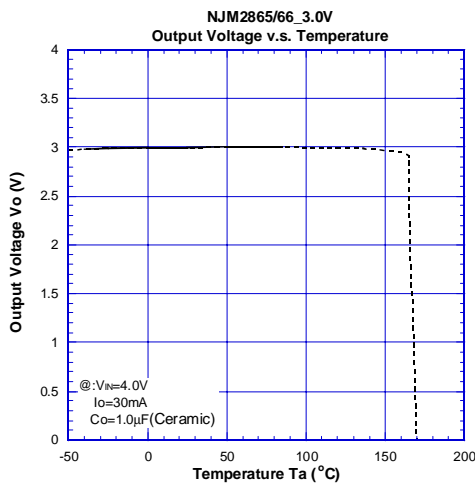
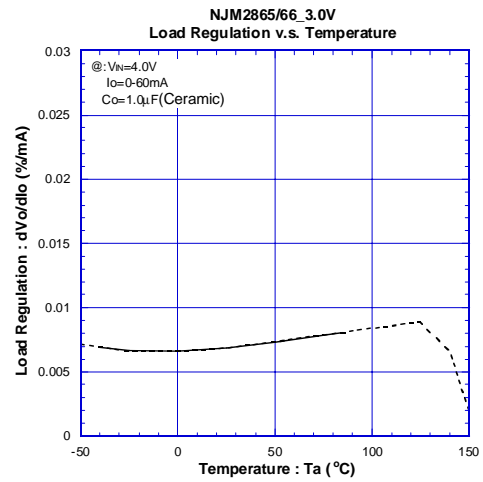
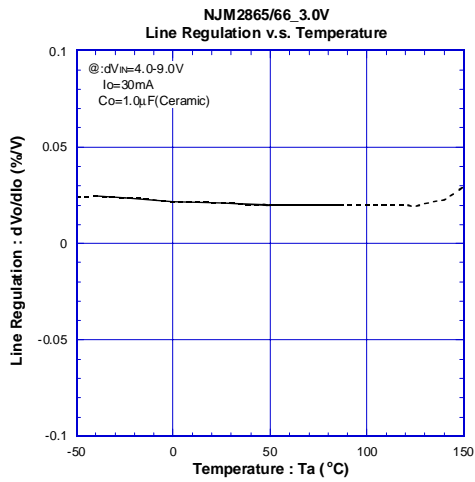

NJM2865/66

ELECTRICAL CHARACTERISTICS

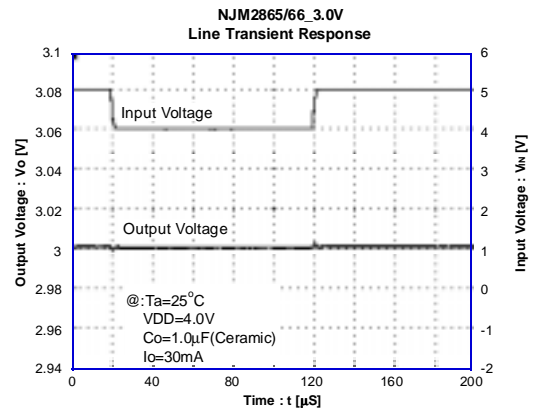
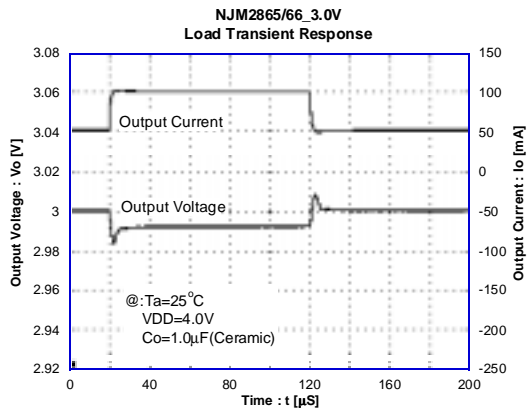

[CAUTION]
The specifications on this databook are only given for information, without any guarantee as regards either mistakes or omissions. The application circuits in this databook are described only to show representative usages of the product and not intended for the guarantee or permission of any right including the industrial rights.